

Date Distributed:



**THE  
NATIONAL  
BOARD**  
OF BOILER AND  
PRESSURE VESSEL  
INSPECTORS

# **NATIONAL BOARD SUBCOMMITTEE INSTALLATION**

## **MINUTES**

---

Meeting of July 14<sup>th</sup>, 2021  
Cincinnati, OH

These minutes are subject to approval and are for committee use only. They are not to be duplicated or quoted for other than committee use.

The National Board of Boiler & Pressure Vessel Inspectors  
1055 Crupper Avenue  
Columbus, Ohio 43229-1183  
Phone: (614)888-8320  
FAX: (614)847-1828

## 1. Call to Order

Chair, M. Wadkinson, called the meeting to order at 8:00 am

## 2. Introduction of Members and Visitors

Introductions took place amongst all members and visitors both in person and Zoom. The attendance sheet was checked off by the Secretary. (See Attachment Pages 1-2)

### Subcommittee Installation

Last Name	First Name	Interest Category	Role	Exp. Date
Wadkinson	Melissa	Manufacturers	Chair	08/30/2021
Wiggins	Edward	Jurisdictional Authorities	Vice Chair	07/30/2023
Bock	Jeanne		Secretary	01/30/2099
Austin	Randall	Users	Member	10/30/2022
Brockman	Joe	Authorized Inspection Agencies	Member	07/30/2023
Creacy	Todd	Authorized Inspection Agencies	Member	01/30/2021
Downs	James	Manufacturers	Member	10/30/2022
Halley	Geoffrey	General Interest	Member	08/30/2021
Konopacki	Stanley	Users	Member	01/30/2023
Patten	Don	Manufacturers	Member	01/30/2023
Richards	H. Michael	General Interest	Member	08/30/2021
Smith	Rex	Authorized Inspection Agencies	Member	01/30/2023
Washington	Milton	Jurisdictional Authorities	Member	01/30/2023

- R. Adams in for Todd Creacy meeting

### 3. Check for a Quorum

With the attached roster and the noted individuals, a quorum was established. There was a motion to approve the roster. The motion was unanimously approved.

#### Subcommittee Installation

Last Name	First Name	Interest Category	Role	Exp. Date
Wadkinson	Melissa	Manufacturers	Chair	08/30/2021
Wiggins	Edward	Jurisdictional Authorities	Vice Chair	07/30/2023
Bock	Jeanne		Secretary	01/30/2099
Austin	Randall	Users	Member	10/30/2022
Brockman	Joe	Authorized Inspection Agencies	Member	07/30/2023
Creacy	Todd	Authorized Inspection Agencies	Member	01/30/2021
Downs	James	Manufacturers	Member	10/30/2022
Halley	Geoffrey	General Interest	Member	08/30/2021
Konopacki	Stanley	Users	Member	01/30/2023
Patten	Don	Manufacturers	Member	01/30/2023
Richards	H. Michael	General Interest	Member	08/30/2021
Smith	Rex	Authorized Inspection Agencies	Member	01/30/2023
Washington	Milton	Jurisdictional Authorities	Member	01/30/2023

- R. Adams in for Todd Creacy.

### 4. Awards/Special Recognition

None for this meeting

### 5. Announcements

- The National Board hosted a reception for all committee members and visitors on Wednesday evening from 5:30pm – 7:30 pm in the Continental Room on the Mezzanine Level.
- The National Board hosted breakfast for all committee members and visitors on Thursday morning at 7:00 am and a lunch at 11:30 am in the Rosewood room on the 4<sup>th</sup> floor of the Hotel.
- A coffee station with snacks was provided in the morning at 10 am and in the afternoon at 1 pm outside of the meeting rooms on the 3<sup>rd</sup> and 4<sup>th</sup> floors.
- The 2021 NBIC is available as of July 1, 2021 and will become mandatory January 1, 2022.
- Each attendee was encouraged to stay muted and use the raise hand feature when wishing to speak.
- Voice voting for each item was used. It was assumed all voted approved asking if anyone is voting “not approved”, “abstention”, or “not voting”.
- All in person attendees were informed that they can see Jonathan in the office to receive a gift.

## 6. Adoption of the Agenda

- Attachment was submitted for item 20-86 and a proposal was added for item 21-01 and 20-35.
- A new item will be opened for reviewing the introduction per M. Wadkinson.
- Item 19-83 added to open PRD item.
- Pat Jennings (AIA) is added to membership nominations to SC.

There was a motion to adopt the Agenda with the noted additions/changes. The motion was unanimously approved.

## 7. Approval of the Minutes of January 13<sup>th</sup>, 2021 Meeting

The minutes are available for review on the National Board website, [www.nationalboard.org](http://www.nationalboard.org).

There was a motion to approve the Minutes of January 13<sup>th</sup>, 2021 as published. The motion was unanimously approved.

## 8. Review of Rosters (See Attachment Pages 1-2)

### • Membership Nominations

Mr. Marvin Byrum (AIA), Mr. Gene Tompkins (Manufacturer), and Mr. Tom Clark (Jurisdictional Authorities) are interested in becoming a member of SG Installation. These gentlemen, along with Mr. Ron Spiker (Jurisdictional Authorities) and Mr. Pat Jennings (AIA), are also interested in becoming members of SC Installation.

- As per NB-240 Section 4.3.3 a. **Subgroup** Member Selection, Approval and Term appointment is selected by the majority vote of the subcommittee membership.

**A vote was taken by the SC for Mr. Marvin Byrum (AIA), Mr. Gene Tompkins (Manufacturer), and Mr. Tom Clark (Jurisdictional Authorities) in becoming a member of the SG. Discussion was held and a motion was made to approve the appointment. The motion was unanimously approved.**

- As per NB-240 Section 4.2.3 a.) **Subcommittee** Member Selection, Approval and Term appointment is selected by majority vote of the NBIC Committee membership.

**Discussion by the SC was held for Mr. Ron Spiker (Jurisdictional Authorities) and Mr. Pat Jennings (AIA) in becoming a member of the SC. This will be voted on in the MC.**

**Mr. Marvin Byrum (AIA), Mr. Gene Tompkins (Manufacturer), and Mr. Tom Clark (Jurisdictional Authorities) will not be recommended for membership to the SC until they have served on the SG.**

- **Membership Reappointments**

Mr. Don Patten, Mr. Eddie Wiggins, Mr. Mike Richards, and Ms. Melissa Wadkinson have memberships to the Subgroup that expire on August 30, 2021.

Ms. Wadkinson and Mr. Richards have memberships to the Subcommittee that expire on August 30, 2021.

- As per NB-240 Section 4.3.3 a. **Subgroup** Member Selection, Approval and Term appointment is selected by the majority vote of the subcommittee membership.

**A vote was taken by the SC for Mr. Don Patten, Mr. Eddie Wiggins, Mr. Mike Richards, and Ms. Melissa Wadkinson to have memberships reappointed to SG. Discussion was held and a motion was made to approve the reappointment. The motion was unanimously approved.**

- As per NB-240 Section 4.2.3 a.) **Subcommittee** Member Selection, Approval and Term appointment is selected by majority vote of the NBIC Committee membership.

**Discussion by the SC was held for Ms. Wadkinson and Mr. Richards to have memberships reappointed to the SC. This will be voted on in the MC.**

- **Officer Appointments**

Ms. Melissa Wadkinson's term as Chair is set to end on August 30, 2021. She is eligible for reappointment to this position.

- As per NB-240 Section 4.2.3 b.) **Subcommittee** Member Selection, Approval and Term appointment is selected by majority vote of the Subcommittee membership.

**A vote was taken by the SC for Ms. Melissa Wadkinson to have term as Chair reappointed on SC. Discussion was held and a motion was made to approve the reappointment. The motion was unanimously approved.**

On Subgroup Mr. Don Patten's and Mr. Eddie Wiggins' terms as Chair and Vice Chair are set to end on August 30, 2021. They are both eligible for reappointment to the positions.

- As per NB-240 Section 4.3.3 b. **Subgroup** Member Selection, Approval and Term appointment is selected by the majority vote of the subcommittee membership.

**A vote was taken by the SC for Mr. Don Patten and Mr. Eddie Wiggins terms as Chair and Vice Chair reappointed on SG. Discussion was held and a motion was made to approve the reappointment. The motion was unanimously approved.**

## 9. Open PRD Items Related to Installation

- NB15-0305 – Create Guidelines for Installation of Overpressure Protection by System Design – D. Marek (PM)
- NB15-0315 – Review isolation valve requirements in Part 1, 4.5.6 and 5.3.6 – D. DeMichael (PM)
- 17-119 – Part 4, 2.2.5 states that pressure setting may exceed 10% range. Clarify by how much – T. Patel (PM). This item is on hold pending ASME action.

M. Wadkinson gave an update on item 17-119 in the SG & SC meeting. Due to some wording confusion between Section I & XIII further research is being conducted.

T. Beirne of Part 4 stated that Item 19-83 should have been on our agenda. After further discussions this item had been sent to us as a letter ballot. Tom will have this re-balloted to our group.

## 10. Interpretations

<b>Item Number:</b> 20-84	<b>NBIC Location:</b> Part 1, 3.7.5.1 d) 4)	<b>Attachment Pages</b> 3-8
<b>General Description:</b> Adjustable Packing on Low Pressure Boiler Stop Valves		
<b>Subgroup:</b> SG Installation		
<b>Task Group:</b> M. Wadkinson (PM), R. Spiker, and M. Downs		
<b>Explanation of Need:</b> Jurisdictions need to know if this requirement applies to all low pressure boiler stop valves (steam, hot water heat, and hot water supply) so they can effectively communicate this requirement to their constituents and can enforce the code when new items are installed.		
<b>Background Information:</b> Most new hot water heating boilers and hot water supply boilers are being installed with appropriately-pressure/temperature-rated butterfly valves as their outlet isolation valves. Most butterfly valves that are installed do not have adjustable pressure-type packing glands. Instead, these valves are supplied with EPDM or Viton seals inside the stem housing to prevent water escape. EPDM is rated to 275 F, and Viton is rated to 300 F. It is unclear whether or not the text of the referenced code is a requirement that is specifically intended to apply to water boilers, or if it is a requirement that has simply been in the code and has carried forward through the years. It is also unclear as to the safety basis for requiring adjustable packing for low pressure hot water boiler stop valves.		
<b>July 2021 Meeting Action:</b> <b>Close with No Action</b> - M. Wadkinson stated that there are words in ASME Section IV item to make a change to the text. A break-out session was held in the SG meeting with the TG to discuss how to address this interpretation. Melissa discussed this with Mr. Cantrel. Item 21-01 was opened which satisfies the inquirer. There was a motion to close with no action. The motion was unanimously approved.		

<b>Item Number:</b> 21-23	<b>NBIC Location:</b> Part 1, S3.1	<b>Attachment Pages</b> 9-11
<b>General Description:</b> Interpretation of scope on Install. of Liquid Carbon Dioxide Storage Vessel		
<b>Subgroup:</b> SG Installation		
<b>Task Group:</b> <del>None assigned.</del> <u>R. Smith (PM), E. Wiggins, and P. Jennings</u>		
<b>Explanation of Need:</b> It is not clear in the NBIC if a closed loop CO2 refrigeration system would fall under this category. If so, this would prohibit the installation of the most common low GWP refrigerants being used for HVAC & refrigeration on stores.		
<b>Background Information:</b> During his site inspection, an inspector in Tennessee stated that this code applies to the refrigeration system's flash tank installed in a machine house on top of a Publix grocery store roof. Since he has rejected it, building cannot continue, and this has jeopardized the build schedule. As stated above, this refrigerant is used all over the US in HVAC & refrigeration systems and is what the government is pushing us to reduce the GWP associated with refrigerants.		
<b>July 2021 Meeting Action:</b> <b>Proposal</b> – The SG and SC held extensive discussions. A TG was assigned being <u>R. Smith (PM), E. Wiggins, and P. Jennings</u> . There was a motion to approve the proposed Question and Reply to the MC. The motion was unanimously approved.		

<b>Item Number:</b> 21-24	<b>NBIC Location:</b> Part 1, 3.7.5.1 b)	<b>Attachment Pages</b> 12-29
<b>General Description:</b> Stop valves on boiler package that is isolated from system water		
<b>Subgroup:</b> SG Installation		
<b>Task Group:</b> <del>None assigned.</del> <u>R. Spiker (PM), R. Austin, and J. Kleiss.</u>		
<b>Explanation of Need:</b> A pool heating packaged manufactured by my employer has been rejected by an inspector because there are no stop valves on the supply and return of the boiler. The inspector references NBIC Part 1, 3.7.5.1 b)1). While clause 3.7.5.1 b)2) could provide an exception for use of stop valves, that is only valid when the boiler is located above the associated system piping.		
<b>Background Information:</b> 3.7.5.1 b) 1) Stop valves shall be located at an accessible point in the supply and return pipe connections as near as is convenient at practicable, of a single hot water boiler installation to permit draining the boiler without emptying the system. 2) When the boiler is located above the system and can be drained without draining the system stop valves required in NBIC Part 1, 3.7.5.1 b) 1) may be eliminated.		
<b>July 2021 Meeting Action:</b> <b>Close with No Action</b> – J. Kleiss presented a summary on this interpretation along with D. Patten providing additional information. After extensive discussions amongst the SG and SC Mr. Kleiss withdrew the interpretation as this will be addressed in a new action item to propose to change wording. There was a motion to close with no action. The motion was unanimously approved. A TG was assigned being <u>R. Spiker (PM), R. Austin, and J. Kleiss.</u>		

## 11. Action Items

<b>Item Number:</b> NB11-1901	<b>NBIC Location:</b> Part 1	<b>Attachment Pages</b> 30-37
<b>General Description:</b> Add guidance for the safe installation of high pressure composite pressure vessels operating in close proximity to the public		
<b>Subgroup:</b> FRP		
<b>Task Group:</b> R. Smith (PM), M. Richards, S. Konopacki, D. Patten and E. Wiggins		
<b>July 2021 Meeting Action:</b> <b>Proposal</b> – Mr. Shelley presented a summary and stated that the revised proposal that incorporates Mr. Smith's comments and making it in line with the revisions to Section X has passed FRP. There was a motion to send the proposal to letter ballot to the SG, then to SC and to Part 4. The motion was unanimously approved.		



<b>Item Number: 20-27</b>	<b>NBIC Location: Part 1, 1.6.9 &amp; S6.3</b>	<b>Attachment Pages 38-46</b>
<b>General Description:</b> Carbon Monoxide Detector/Alarm NBIC 2019		
<b>Subgroup:</b> SG Installation		
<b>Task Group:</b> E. Wiggins (PM), G. Tompkins (PM), R. Spiker, R. Smith, S. Konopacki and R. Austin		
<b>Explanation of Need:</b> These codes are being enforced by some jurisdictions on existing installations. Inspectors need to know what codes we need to enforce. Do the detectors have specific levels of CO when an alarm is to go off? Is there a requirement for an audible alarm or decibel level of the alarm? Where in the boiler room should the alarm/monitor be mounted?		
<b>July 2021 Meeting Action: Proposal</b> – The (PM) moved to E. Wiggins from G. Tompkins. In the January 2021 MC meeting after discussion, Ms. Wadkinson agreed to rescind the original motion of closing this item if Mr. Troutt and Mr. Newton agreed to help the task group develop a proposal. Mr. Troutt presented his proposal giving his concerns\importance of this item. The SC held extensive discussions on the proposal. There was a motion to send the proposal to letter ballot to the SG, then to SC and then to MC. The motion was unanimously approved.		

<b>Item Number: 20-33</b>	<b>NBIC Location: Part 1</b>	<b>No Attachment</b>
<b>General Description:</b> Flow or Temp Sensing Devices forced Circulation Boilers		
<b>Subgroup:</b> SG Installation		
<b>Task Group:</b> M. Downs (PM), D. Patten, M. Wadkinson		
<b>Explanation of Need:</b> Incorporation of applicable CSD-1 requirements.		
<b>July 2021 Meeting Action: Progress Report</b> – The TG reported they were not able to hold discussions on this item prior to this meeting. A break-out session was held in the SG meeting to further discuss this item. The TG will continue to work on this item to have a proposal by the January 2022 meeting.		

<b>Item Number: 20-34</b>	<b>NBIC Location: Part 1</b>	<b>Attachment Pages 47-61</b>
<b>General Description:</b> Venting of gas train components		
<b>Subgroup:</b> SG Installation		
<b>Task Group:</b> P. Jennings (PM), M. Washington, R. Adams		
<b>Explanation of Need:</b> Incorporation of applicable CSD-1 requirements.		
<b>July 2021 Meeting Action: Proposal</b> – P. Jennings presented a proposal. The SG & SC held discussions on the proposal. There was a motion to approve this proposal to be sent to Letter Ballot to the SG, then to the SC with a Review and Comment for MC. The motion was unanimously approved.		

<b>Item Number: 20-35</b>	<b>NBIC Location: Part 1</b>	<b>Attachment Page 62</b>
<b>General Description:</b> Installation requirements for Fuel Oil Trains		
<b>Subgroup:</b> SG Installation		
<b>Task Group:</b> G. Tompkins (PM), D. Patten, M. Washington		
<b>Explanation of Need:</b> Incorporation of applicable CSD-1 requirements.		
<b>July 2021 Meeting Action: Close with No Action</b> – G. Tompkins presented a proposal on item 20-34 that incorporates this item 20-35. There was a motion to close this item with no action. The motion was unanimously approved.		

<b>Item Number: 20-39</b>	<b>NBIC Location: Part 1</b>	<b>No Attachment</b>
<b>General Description:</b> Modular Boilers		
<b>Subgroup:</b> SG Installation		
<b>Task Group:</b> T. Clark (PM), M. Downs, M. Wadkinson, D. Patten, R. Austin		
<b>Explanation of Need:</b> Incorporation of applicable CSD-1 requirements.		
<b>July 2021 Meeting Action: Progress Report</b> – T. Clark presented an overview on this item. It was stated that the Section IV 2021 Edition has been restructured on Modular Boilers. Tom will review and have a proposal for the next meeting in January 2022.		

<b>Item Number: 20-41</b>	<b>NBIC Location: Part 1</b>	<b>Attachment Page 63</b>
<b>General Description:</b> Safety and Safety Relief Valves for Steam and Hot Water Heating Boilers.		
<b>Subgroup:</b> SG Installation		
<b>Task Group:</b> E. Wiggins (PM), J. Brockman, G. Tompkins		
<b>Explanation of Need:</b> Incorporation of applicable CSD-1 requirements.		
<b>July 2021 Meeting Action: Proposal</b> – The SG and SC reviewed the proposal and agrees with PRD’s comments\changes. There was a motion to approve to Letter Ballot to the SG, then to SC and to PRD for vote. The motion was unanimously approved.		

<b>Item Number: 20-43</b>	<b>NBIC Location: Part 1</b>	<b>Attachment Page 64</b>
<b>General Description:</b> Safety Relief valve for Hot Water Supply Boilers		
<b>Subgroup:</b> SG Installation		
<b>Task Group:</b> W. Anderson (PM), E. Wiggins, J. Brockman		
<b>Explanation of Need:</b> Incorporation of applicable CSD-1 requirements.		
<b>July 2021 Meeting Action: Proposal</b> - The SG and SC reviewed the proposal and agrees with PRD’s comments\changes. There was a motion to approve to Letter Ballot to the SG, then to SC and to PRD for vote. The motion was unanimously approved.		

<b>Item Number: 20-44</b>	<b>NBIC Location: Part 1</b>	<b>Attachment Pages 65-67</b>
<b>General Description:</b> CW Vacuum Boilers		
<b>Subgroup:</b> SG Installation		
<b>Task Group:</b> R. Spiker (PM), M. Washington, and M. Byrum		
<b>Explanation of Need:</b> Incorporation of applicable CSD-1 requirements.		
<b>July 2021 Meeting Action: Proposal</b> – The SG and SC held discussions to revise the proposal and then agreed that this should be sent out as a Letter Ballot for review and comment to the SG, then to the SC. There was a motion to LB to the SG then to the SC. The motion was unanimously approved.		

<b>Item Number: 20-62</b>	<b>NBIC Location: Part 1, 1.4.5.1</b>	<b>No Attachment</b>
<b>General Description:</b> Update the National Board Boiler Installation Report		
<b>Subgroup:</b> SG Installation		
<b>Task Group:</b> T. Clark (PM), E. Wiggins, R. Spiker, T. Creacy, P. Jennings, G. Tompkins, and D. Patten.		
<b>Explanation of Need:</b> The form has not been updated in years. The form will be part of the National Boards Jurisdictional Reporting System which is currently under development.		
<b>July 2021 Meeting Action: Progress Report</b> – T. Clark presented a summary of follow-up survey results that has been completed on this item. He will continue to gather additional information to support the applicable updating of the report form.		

<b>Item Number: 20-86</b>	<b>NBIC Location: Part 1, 2.10.1 a)</b>	<b>Attachment Pages 68-71</b>
<b>General Description:</b> Testing and Acceptance: Boiling-out Procedure		
<b>Subgroup:</b> SG Installation		
<b>Task Group:</b> E. Wiggins (PM), D. Patten, M. Washington and S. Konopacki.		
<b>Explanation of Need:</b> This was brought to my (Mr. Eddie Wiggins) attention by Ernest Brantley. Mr. Brantley indicated during an acceptance inspection, he found boiler with excessive oil on the tubes and tube sheet after boiler was delivered and installed. He could not find any reference to boil- out to remove this extraneous material.		
<b>July 2021 Meeting Action: Progress Report</b> – The SG & SC held discussions on this item with sharing additional attachment information. M. Wadkinson suggested doing this as a supplement and to include Part 2 and Part 3. The TG will look over the attachment with hopes of having a proposal by the next meeting in January 2022.		

## 12. New Items:

Item Number: 21-01	NBIC Location: Part 1, 3.7.5.1 d)	Attachment Page 72
<b>General Description:</b>		
<b>Subgroup:</b> SG Installation		
<b>Task Group:</b> <del>None Assigned</del> <u>M. Wadkinson</u>		
<b>Explanation of Need:</b> Add verbiage for use of Valves that do not have adjustable packing. Not for steam use.		
<b>July 2021 Meeting Action: Proposal</b> – A TG was assigned being M. Wadkinson (PM). A proposal was presented by M. Wadkinson. The SG & SC held discussions and approves of the proposal. There was a motion to approve to the MC. The motion was unanimously approved.		

## 13. Future Meetings

- January 18-21, 2022 – San Diego, CA
- July 2022 - TBD

## 14. Adjournment

A motion was made and unanimously approved to adjourn the meeting at 11:45 am

Respectfully submitted,

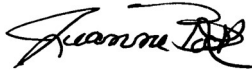

Jeanne Bock  
NBIC Part 1 Secretary

## National Board Inspection Code Committee Structure / Committee Members

A listing of NBIC Main Committee, Subcommittee, and Subgroup members is also shown in the introductory pages in the current edition of NBIC Part 1, NBIC Part 2, NBIC Part 3, and NBIC Part 4.

Committee Name:

- NBIC Main Committee
- Subcommittee Installation

*11 Not 6*

*in person zoom*

Last Name	First Name	Interest Category	Role	Exp. Date	More
Wadkinson	Melissa	Manufacturers	Chair	08/30/2021	<a href="#">Details</a>
Wiggins	Edward	Jurisdictional Authorities	Vice Chair	07/30/2023	<a href="#">Details</a>
Bock	Jeanne		Secretary	01/30/2099	<a href="#">Details</a>
Austin	Randall	Users	Member	10/30/2022	<a href="#">Details</a>
Brockman	Joe	Authorized Inspection Agencies	Member	07/30/2023	<a href="#">Details</a>
Creacy	Todd	Authorized Inspection Agencies	Member	01/30/2024	<a href="#">Details</a>
Downs	James	Manufacturers	Member	10/30/2022	<a href="#">Details</a>
Halley	Geoffrey	General Interest	Member	08/30/2021	<a href="#">Details</a>
Konopacki	Stanley	Users	Member	01/30/2023	<a href="#">Details</a>
Patten	Don	Manufacturers	Member	01/30/2023	<a href="#">Details</a>
Richards	H. Michael	General Interest	Member	08/30/2021	<a href="#">Details</a>
Smith	Rex	Authorized Inspection Agencies	Member	01/30/2023	<a href="#">Details</a>
Washington	Milton	Jurisdictional Authorities	Member	01/30/2023	<a href="#">Details</a>

✓  
✓  
✓  
✓  
✓  
X  
X  
✓  
✓  
✓  
X

✓  
✓  
✓  
✓  
✓  
✓  
~~✓~~  
✓  
✓  
✓  
✓

*R. Adams*

- Subcommittee Inspection
- Subcommittee Repairs/Alterations
- Subcommittee Pressure Relief Devices
- Subgroup Installation

Last Name	First Name	Interest Category	Role	Exp. Date	More
Patten	Don	Manufacturers	Chair	08/30/2021	<a href="#">Details</a>
Wiggins	Edward	Jurisdictional Authorities	Vice Chair	08/30/2021	<a href="#">Details</a>
Bock	Jeanne		Secretary	01/30/2099	<a href="#">Details</a>
Anderson	William	Jurisdictional Authorities	Member	06/29/2022	<a href="#">Details</a>
Austin	Randall	Users	Member	10/30/2022	<a href="#">Details</a>
Brockman	Joe	Authorized Inspection Agencies	Member	01/30/2023	<a href="#">Details</a>
Creacy	Todd	Authorized Inspection Agencies	Member	01/30/2023	<a href="#">Details</a>
Downs	James	Manufacturers	Member	01/30/2023	<a href="#">Details</a>
Halley	Geoffrey	General Interest	Member	08/30/2021	<a href="#">Details</a>
Jennings	Patrick	Authorized Inspection Agencies	Member	01/30/2023	<a href="#">Details</a>
Konopacki	Stanley	Users	Member	01/30/2023	<a href="#">Details</a>
Richards	H. Michael	General Interest	Member	08/30/2021	<a href="#">Details</a>
Smith	Rex	Authorized Inspection Agencies	Member	01/30/2023	<a href="#">Details</a>
Spiker	Ronald	Jurisdictional Authorities	Member	06/29/2022	<a href="#">Details</a>
Wadkinson	Melissa	Manufacturers	Member	08/30/2021	<a href="#">Details</a>
Washington	Milton	Jurisdictional Authorities	Member	07/30/2023	<a href="#">Details</a>

✓  
✓

*in person zoom*

- Subgroup Inspection



My Account Sign Out



- Task Group Historical Boilers
- Task Group NR
- Task Group Interpretations (Repairs/Alterations)

ABOUT US

- [Functions and Resources](#)
- [Mission Statement](#)
- [Our First 100 Years](#)
- [Visiting NBBI](#)
- [Site Map](#)

POLICIES

- [Logo and Marks](#)
- [Delivery/Return](#)
- [Disclaimer](#)
- [Terms of Use](#)
- [Privacy](#)

FEATURES

- [COVID-19 Updates](#)
- [Technical Scholarship](#)
- [C. O. Myers Safety Medal](#)

CONTACT US

- [Directory](#)

Copyright © 2021 The National Board of Boiler and Pressure Vessel Inspectors  
1055 Crupper Avenue Columbus, OH 43229 Ph.614.888.8320

Visitors in person zoom

- | Visitors           | in person          | zoom                        |
|--------------------|--------------------|-----------------------------|
| ✓ Rodger Adams     | in for T. Cready ✓ |                             |
| ✓ Marvin Byrum     | ✓                  |                             |
| ✗ Julius Dacanay   |                    | ✗ ✓                         |
| ✗ M.A. Shah        |                    | ✗ ✓                         |
| ✓ Tom Clark        |                    | ✓                           |
| ✓ Patrick Jennings |                    | ✓ → (member of SG not SC)   |
| ✗ William Anderson |                    | ✗ ✓ → (member of SG not SC) |
| ✗ David warshall   |                    | ✗ ✓                         |
| ✓ Me. Shelley      |                    | ✓ → FRP                     |
| ✓ Gene Tompkins    |                    |                             |
| ✓ Bob W            |                    |                             |
| ✓ LWS P            |                    |                             |
| ✓ Kleiss           |                    |                             |
| ✓ Donny LaSage     |                    |                             |

## PROPOSED INTERPRETATION

<b>Inquiry No.</b>	<b>20-84</b>
<b>Source</b>	Chris Cantrell, State of Nebraska Christopher.Cantrell@nebraska.gov
<b>Subject</b>	Adjustable Packing on Low Pressure Boiler Stop Valves  <b>Background:</b> Most new hot water heating boilers and hot water supply boilers are being installed with appropriately-pressure/temperature-rated butterfly valves as their outlet isolation valves. Most butterfly valves that are installed do not have adjustable pressure-type packing glands. Instead, these valves are supplied with EPDM or Viton seals inside the stem housing to prevent water escape. EPDM is rated to 275 F, and Viton is rated to 300 F. It is unclear whether or not the text of the referenced code is a requirement that is specifically intended to apply to water boilers, or if it is a requirement that has simply been in the code and has carried forward through the years. It is also unclear as to the safety basis for requiring adjustable packing for low pressure hot water boiler stop valves.
<b>Edition</b>	<b>Part 1, 3.7.5.1 d) 4)</b>
<b>Question</b>	Does the requirement in NBIC, Part 1, Section 3, paragraph 3.7.5.1(d)(4) that all valves or cocks with stems or spindles shall have adjustable pressure-type packing glands apply to stop valves used on low pressure hot water heating or hot water supply boilers?
<b>Reply</b>	No. This requirement applies to stop valves used on low pressure steam boilers only.
<b>Committee's Question</b>	
<b>Committee's Reply</b>	
<b>Rationale</b>	

**PROPOSED INTERPRETATION**

<b>Item No.</b>
20-84
<b>Subject/Title</b>
Adjustable Packing on Low Pressure Boiler Stop Valves
<b>Project Manager and Task Group</b>
Melissa Wadkinson, Subcommittee Installation
<b>Source (Name/Email)</b>
Christopher Cantrell, CLSSEGB / Christopher.Cantrell@nebraska.gov
<b>Statement of Need</b>
Jurisdictions need to know if this requirement applies to all low pressure boiler stop valves (steam, hot water heat, and hot water supply) so they can effectively communicate this requirement to their constituents and can enforce the code when new items are installed.
<b>Background Information</b>
Most new hot water heating boilers and hot water supply boilers are being installed with appropriately-pressure/temperature-rated butterfly valves as their outlet isolation valves. Most butterfly valves that are installed do not have adjustable pressure-type packing glands. Instead, these valves are supplied with EPDM or Viton seals inside the stem housing to prevent water escape. EPDM is rated to 275 F, and Viton is rated to 300 F. It is unclear whether or not the text of the referenced code is a requirement that is specifically intended to apply to water boilers, or if it is a requirement that has simply been in the code and has carried forward through the years. It is also unclear as to the safety basis for requiring adjustable packing for low pressure hot water boiler stop valves.
<b>Proposed Question</b>
Does the requirement in NBIC, Part 1, Section 3, paragraph 3.7.5.1(d)(4) that all valves or cocks with stems or spindles shall have adjustable pressure-type packing glands apply to stop valves used on low pressure hot water heating or hot water supply boilers?
<b>Proposed Reply</b>
No. This requirement applies to stop valves used on low pressure steam boilers only.
<b>Committee's Question 1</b>
<b>Committee's Reply 1</b>
<b>Rationale</b>
<b>Committee's Question 2</b>
<b>Committee's Reply 2</b>
<b>Rationale</b>



VOTE:							
COMMITTEE	Approved	Disapproved	Abstained	Not Voting	Passed	Failed	Date

## CODE INTERPRETATIONS

Requests for code Interpretations shall provide the following:

**a) Inquiry**

Provide a condensed and precise question, omitting superfluous background information and, when possible, composed in such a way that a "yes" or a "no" reply, with brief provisos if needed, is acceptable. The question should be technically and editorially correct.

**b) Reply**

Provide a proposed reply that clearly and concisely answer the inquiry question. Preferably the reply should be "yes" or "no" with brief provisos, if needed.

**c) Background Information**

Provide any background information that will assist the committee in understanding the proposed Inquiry and Reply. Requests for Code Interpretations must be limited to an interpretation of the particular requirement in the code. The Committee cannot consider consulting type requests such as:

- 1) A review of calculations, design drawings, welding qualifications, or descriptions of equipment or Parts to determine compliance with code requirements;
- 2) A request for assistance in performing any code-prescribed functions relating to, but not limited to, material selection, designs, calculations, fabrication, inspection, pressure testing, or installation; or
- 3) A request seeking the rationale for code requirements.

**Jeanne Bock**

---

**From:** Melissa Wadkinson <Melissa.Wadkinson@fulton.com>  
**Sent:** Tuesday, July 13, 2021 1:14 PM  
**To:** dpatten@baycityboiler.com; Edward Wiggins; Jeanne Bock  
**Subject:** Fw: NBIC Interpretation request 20-84

From Chris regarding his interpretation request. thanks,  
Melissa

---

**From:** Cantrell, Christopher <Christopher.Cantrell@nebraska.gov>  
**Sent:** Tuesday, July 13, 2021 12:13 PM  
**To:** Melissa Wadkinson <Melissa.Wadkinson@fulton.com>  
**Subject:** RE: NBIC Interpretation request 20-84

Melissa,  
Thank you for your hard work, dedication, and follow-through on this item. I truly appreciate your effort and collaboration.

Because of the details you provided and the work that you and the committees and groups have done, you may consider this email my permission for you to withdraw my interpretation request, 20-84, and consider the matter closed.

Please enter this email into the minutes and let the record reflect how much I appreciate you and your team's outstanding work.

Thank you!

Be safe,

**Christopher B. Cantrell, CLSSEGB**  
*State Fire Marshal*  
*Chief Boiler Inspector*

**Nebraska State Fire Marshal Agency**  
246 S. 14<sup>th</sup> Street, Suite 1  
Lincoln, NE 68508  
OFFICE 402-471-9471  
CELL 402-429-5418  
[christopher.cantrell@nebraska.gov](mailto:christopher.cantrell@nebraska.gov)

[sfm.nebraska.gov](http://sfm.nebraska.gov) | [Facebook](#) | [Twitter](#) | [YouTube](#)  
Arson Hotline 1-888-WY-ARSON

---

**From:** Melissa Wadkinson <Melissa.Wadkinson@fulton.com>  
**Sent:** Tuesday, July 13, 2021 10:53 AM  
**To:** Cantrell, Christopher <Christopher.Cantrell@nebraska.gov>  
**Subject:** NBIC Interpretation request 20-84

Good morning Chris,

As discussed, in NBIC Part 1 there is a proposal (attached) to modify the words in paragraph 3.7.5.1 d) 4) to address that valves other than those with adjustable packing glands may be used for isolation. ASME Section IV has a standards committee approved item which will be going to board ballot and the NBIC item above is proceeding to SC Installation tomorrow.

Do these changes satisfy your concerns and would you be willing to withdraw your interpretation item?

Thank you,

Melissa

## PROPOSED INTERPRETATION

<b>Inquiry No.</b>	<b>21-23</b>
<b>Source</b>	Joseph Richardson, Dover Food Retail <a href="mailto:jrichardson@doverfoodretail.com">jrichardson@doverfoodretail.com</a>
<b>Subject</b>	<p>Interpretation of scope on Install. of Liquid Carbon Dioxide Storage Vessel</p> <p><b>Background:</b> It is not clear in the NBIC if a closed loop CO2 refrigeration system would fall under this category. If so, this would prohibit the installation of the most common low GWP refrigerants being used for HVAC &amp; refrigeration on stores. During a site inspection, an inspector in Tennessee stated that this code applies to the refrigeration system's flash tank installed in a machine house on top of a Publix grocery store roof. Since he has rejected it, building cannot continue and this has jeopardized the build schedule. As stated above, this refrigerant is used all over the US in HVAC &amp; refrigeration systems and is what the government is pushing us to reduce the GWP associated with refrigerants.</p>
<b>Edition</b>	<b>Part 1, S3.1</b>
<b>Question</b>	Does the flash tank on an enclosed refrigeration system fall under the scope of this listing since it is a closed loop system that is not refilled?
<b>Reply</b>	No.
<b>Committee's Question</b>	<b>Do the requirements of Supplement 3 of NBIC Part 1 apply to a closed loop refrigeration system that utilizes carbon dioxide as a working fluid?</b>
<b>Committee's Reply</b>	<b>No</b>
<b>Rationale</b>	<b>The flash tank of this closed loop system is not a fill in place system.</b>

## SUPPLEMENT 3 INSTALLATION OF LIQUID CARBON DIOXIDE STORAGE VESSELS

### S3.1 SCOPE

This supplement provides requirements and guidelines for the installation of Liquid Carbon Dioxide Storage Vessels (LCDSVs), fill boxes, fill lines, and pressure relief discharge/vent circuits used for carbonated beverage systems, swimming pool pH control systems, and other fill in place systems storing 1,000 lbs (454 kg) or less of liquid CO<sub>2</sub>.

### S3.2 GENERAL REQUIREMENTS STORAGE TANK LOCATION

LCDSVs should be installed in an unenclosed area whenever possible. LCDSVs that do not meet all criteria for an unenclosed area shall be considered an enclosed area installation. An unenclosed area:

- a) Shall be outdoors;
- b) Shall be above grade; and
- c) Shall not obstruct more than three sides of the perimeter with supports and walls. At least 25% of the perimeter area as calculated from the maximum height of the storage container shall be open to atmosphere and openings shall be in direct conveyance with ground level.

#### S3.2.1 GENERAL REQUIREMENTS (ENCLOSED AND UNENCLOSED AREAS)

- a) LCDSVs shall not be located within 10 feet (3,050 mm) of elevators, unprotected platform ledges, or other areas where falling would result in dropping distances exceeding half the container height.
- b) LCDSVs shall be installed with sufficient clearance for filling, operation, maintenance, inspection, and replacement.
- c) Orientation of nozzles and attachments shall be such that sufficient clearance between the nozzles, attachments, and the surrounding structures is maintained during the installation, the attachment of associated piping, and operation.
- d) LCDSVs shall not be installed on roofs.
- e) LCDSVs shall be safely supported. Vessel supports, foundations, and settings shall be in accordance with jurisdictional requirements, manufacturer recommendations and/or other industry standards as applicable. The weight of the vessel when full of liquid carbon dioxide shall be considered when designing vessel supports. Design of supports, foundations, and settings shall consider vibration (including seismic and wind loads where necessary), movement (including thermal movement), and loadings. Vessel foundations or floors in multistory buildings must be capable of supporting the full system weight and in accordance with building codes.
- f) LCDSVs shall not be installed within 36 in. (915 mm) of electrical panels.
- g) LCDSVs installed outdoors in areas in the vicinity of vehicular traffic shall be guarded to prevent accidental impact by vehicles. The guards or bollards shall be installed in accordance with local building codes or to a national recognized standard when no local building code exists.
- h) LCDSVs shall be equipped with isolation valves in accordance with paragraph NBIC Part 1, S3.6.

## SUPPLEMENT 3 INSTALLATION OF LIQUID CARBON DIOXIDE STORAGE VESSELS

### S3.1 SCOPE

This supplement provides requirements and guidelines for the installation of Liquid Carbon Dioxide Storage Vessels (LCDSVs), fill boxes, fill lines, and pressure relief discharge/vent circuits used for carbonated beverage systems, swimming pool pH control systems, and other fill in place systems storing 1,000 lbs (454 kg) or less of liquid CO<sub>2</sub>.

### S3.2 GENERAL REQUIREMENTS STORAGE TANK LOCATION

LCDSVs should be installed in an unenclosed area whenever possible. LCDSVs that do not meet all criteria for an unenclosed area shall be considered an enclosed area installation. An unenclosed area:

- a) Shall be outdoors;
- b) Shall be above grade; and
- c) Shall not obstruct more than three sides of the perimeter with supports and walls. At least 25% of the perimeter area as calculated from the maximum height of the storage container shall be open to atmosphere and openings shall be in direct conveyance with ground level.

#### S3.2.1 GENERAL REQUIREMENTS (ENCLOSED AND UNENCLOSED AREAS)

- a) LCDSVs shall not be located within 10 feet (3,050 mm) of elevators, unprotected platform ledges, or other areas where falling would result in dropping distances exceeding half the container height.
- b) LCDSVs shall be installed with sufficient clearance for filling, operation, maintenance, inspection, and replacement.
- c) Orientation of nozzles and attachments shall be such that sufficient clearance between the nozzles, attachments, and the surrounding structures is maintained during the installation, the attachment of associated piping, and operation.
- d) LCDSVs shall not be installed on roofs.
- e) LCDSVs shall be safely supported. Vessel supports, foundations, and settings shall be in accordance with jurisdictional requirements, manufacturer recommendations and/or other industry standards as applicable. The weight of the vessel when full of liquid carbon dioxide shall be considered when designing vessel supports. Design of supports, foundations, and settings shall consider vibration (including seismic and wind loads where necessary), movement (including thermal movement), and loadings. Vessel foundations or floors in multistory buildings must be capable of supporting the full system weight and in accordance with building codes.
- f) LCDSVs shall not be installed within 36 in. (915 mm) of electrical panels.
- g) LCDSVs installed outdoors in areas in the vicinity of vehicular traffic shall be guarded to prevent accidental impact by vehicles. The guards or bollards shall be installed in accordance with local building codes or to a national recognized standard when no local building code exists.
- h) LCDSVs shall be equipped with isolation valves in accordance with paragraph NBIC Part 1, S3.6.

## PROPOSED INTERPRETATION

<b>Inquiry No.</b>	<b>21-24</b>
<b>Source</b>	Jeff Kleiss, Lochinvar, LLC jkleiss@lochinvar.com
<b>Subject</b>	Stop valves on boiler package that is isolated from system water  <b>Background:</b> A pool heating packaged manufactured by my employer has been rejected by an inspector because there are no stop valves on the supply and return of the boiler. The inspector references NBIC Part 1, 3.7.5.1 b)1). While clause 3.7.5.1 b)2) could provide an exception for use of stop valves, that is only valid when the boiler is located above the associated system piping.
<b>Edition</b>	<b>Part 1, 3.7.5.1 b)</b>
<b>Question</b>	When a boiler is part of a package with an indirect heat exchanger that isolates the boiler from the primary system water are the stop valves mentioned in NBIC Part 1, 3.7.5.1 b)1) required to be installed on the boiler supply and return?
<b>Reply</b>	No.
<b>Committee's Question</b>	
<b>Committee's Reply</b>	
<b>Rationale</b>	



**PROPOSED INTERPRETATION**

<b>Item No.</b>
21-24
<b>Subject/Title</b>
Stop valves on boiler package that is isolated from system water
<b>Project Manager and Task Group</b>
<b>Source (Name/Email)</b>
Jeff Kleiss / jkleiss@lochinvar.com
<b>Statement of Need</b>
A pool heating packaged manufactured by my employer has been rejected by an inspector because there are no stop valves on the supply and return of the boiler. The inspector references NBIC Part 1, 3.7.5.1 b)1). While clause 3.7.5.1 b)2) could provide an exception for use of stop valves, that is only valid when the boiler is located above the associated system piping.
<b>Background Information</b>
3.7.5.1 b) 1) Stop valves shall be located at an accessible point in the supply and return pipe connections as near as is convenient at practicable, of a single hot water boiler installation to permit draining the boiler without emptying the system. 2) When the boiler is located above the system and can be drained without draining the system stop valves required in NBIC Part 1, 3.7.5.1 b) 1) may be eliminated.
<b>Proposed Question</b>
When a boiler is part of a package with an indirect heat exchanger that isolates the boiler from the primary system water are the stop valves mentioned in NBIC Part 1, 3.7.5.1 b)1) required to be installed on the boiler supply and return?
<b>Proposed Reply</b>
No.
<b>Committee's Question 1</b>
<b>Committee's Reply 1</b>
<b>Rationale</b>
<b>Committee's Question 2</b>
<b>Committee's Reply 2</b>
<b>Rationale</b>

<b>VOTE:</b>							
<b>COMMITTEE</b>	<b>Approved</b>	<b>Disapproved</b>	<b>Abstained</b>	<b>Not Voting</b>	<b>Passed</b>	<b>Failed</b>	<b>Date</b>

## CODE INTERPRETATIONS

Requests for code Interpretations shall provide the following:

**a) Inquiry**

Provide a condensed and precise question, omitting superfluous background information and, when possible, composed in such a way that a "yes" or a "no" reply, with brief provisos if needed, is acceptable. The question should be technically and editorially correct.

**b) Reply**

Provide a proposed reply that clearly and concisely answer the inquiry question. Preferably the reply should be "yes" or "no" with brief provisos, if needed.

**c) Background Information**

Provide any background information that will assist the committee in understanding the proposed Inquiry and Reply. Requests for Code Interpretations must be limited to an interpretation of the particular requirement in the code. The Committee cannot consider consulting type requests such as:

- 1) A review of calculations, design drawings, welding qualifications, or descriptions of equipment or Parts to determine compliance with code requirements;
- 2) A request for assistance in performing any code-prescribed functions relating to, but not limited to, material selection, designs, calculations, fabrication, inspection, pressure testing, or installation; or
- 3) A request seeking the rationale for code requirements.

**Jeanne Bock**

**From:** Kleiss, Jeff <jkleiss@lochinvar.com>  
**Sent:** Friday, April 30, 2021 2:04 PM  
**To:** Don Patten  
**Cc:** Edward Wiggins; Jeanne Bock; melissa.wadkinson@fulton-management.com  
**Subject:** RE: New Interpretation Request for Review  
**Attachments:** 713696AQP-06.pdf

Don,

I don't have photos of the installation but I have attached the brochure for the packages we build showing the piping arrangement on the last page. Will this suffice or would you like me to try to get some pictures from the particular installation?

Regards,



**Jeff Kleiss**  
*Senior Project Engineer - Certification*

**Lochinvar, LLC**  
 300 Maddox Simpson Parkway • Lebanon, TN  
 P:615.889.8901 X:2224 • [www.Lochinvar.com](http://www.Lochinvar.com)

**From:** Don Patten <dpatten@baycityboiler.com>  
**Sent:** Friday, April 30, 2021 12:56 PM  
**To:** Kleiss, Jeff <jkleiss@lochinvar.com>  
**Cc:** Wiggins, Edward F 'Eddie' <edward.wiggins@labor.alabama.gov>; jbock@nationalboard.org; melissa.wadkinson@fulton-management.com  
**Subject:** RE: New Interpretation Request for Review



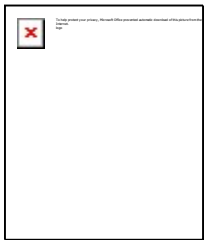

This message has originated from an **External Source**. Please use proper judgment and caution when opening attachments, clicking links, or responding to this email.

Jeff, do you have a drawing or pictures of the installation for reference?



[baycityboiler.com](http://baycityboiler.com)

**Don Patten**  
 V.P of Sales

 Office: (510) 786-3711  
 Mobile: (925) 364-1904  
 dpatten@baycityboiler.com  
 [www.baycityboiler.com](http://www.baycityboiler.com)  
 [baycityboiler.com](http://baycityboiler.com)  
 Hayward, Stockton, Fresno

**23312 Cabot Blvd, Hayward, CA  
 94545**

 [facebook.com](https://www.facebook.com)

 [linkedin.com](https://www.linkedin.com)

Sales [[baycityboiler.com](http://baycityboiler.com)] | Service [[baycityboiler.com](http://baycityboiler.com)] |  
 Parts [[baycityboiler.com](http://baycityboiler.com)] | Rental [[baycityboiler.com](http://baycityboiler.com)] |  
 24/7 Emergency Service [[baycityboiler.com](http://baycityboiler.com)]

---

**From:** NBIC Interpretations Request <[NBICInquiry@nationalboard.org](mailto:NBICInquiry@nationalboard.org)>  
**Sent:** Friday, April 30, 2021 7:43 AM  
**To:** Don Patten <[dpatten@baycityboiler.com](mailto:dpatten@baycityboiler.com)>  
**Cc:** Wiggins, Edward F 'Eddie' <[edward.wiggins@labor.alabama.gov](mailto:edward.wiggins@labor.alabama.gov)>; [jbock@nationalboard.org](mailto:jbock@nationalboard.org);  
[melissa.wadkinson@fulton-management.com](mailto:melissa.wadkinson@fulton-management.com)  
**Subject:** New Interpretation Request for Review



April 30, 2021

Dear Don Patten,

This email is being sent as notification that a new Interpretation Request has been submitted for Subgroup Installation and Subcommittee Installation. Please review the details of the new item below:

Inquirer:	Jeff Kleiss
Inquirer Contact Email:	<a href="mailto:jkleiss@lochivar.com">jkleiss@lochivar.com</a>
Phone:	+1 (615) 889-8901
Item Number:	21-24 (I)
Item Title:	Stop valves on boiler package that is isolated from system water
NBIC Code Section:	
<b><u>Part</u></b>	<b><u>Section</u></b>
Installation	3; Paragraph: 3.7.5.1b
Explanation of Need:	A pool heating packaged manufactured by my employer has been rejected by an inspector because there are no stop valves on the supply and return of the boiler. The inspector references NBIC Part 1, 3.7.5.1 b)1). While clause 3.7.5.1 b)2) could provide an exception for use of stop valves, that is only valid when the boiler is located above the associated system piping.
Background Information:	3.7.5.1 b) 1) Stop valves shall be located at an accessible point in the supply and return pipe connections as near as is convenient at practicable, of a single hot water boiler installation to permit draining the boiler without emptying the system. 2) When the boiler is located above the system and can be drained without draining the system stop valves required in NBIC Part 1, 3.7.5.1 b) 1) may be eliminated.
Question:	When a boiler is part of a package with an indirect heat exchanger that isolates the boiler from the primary system water are the stop valves mentioned in NBIC Part 1, 3.7.5.1 b)1) required to be installed on the boiler supply and return?
Proposed Reply:	No.

You are encouraged to work with your subgroup/subcommittee to assign a Project Manager and Task Group to begin preliminary work on this item. Please contact your subgroup/subcommittee secretary and the NBIC secretary when a Project Manager and Task Group have been assigned for this item.

Please contact me if you have any additional questions.

Jonathan Ellis  
Staff Engineer  
The National Board of Boiler and Pressure Vessel Inspectors  
1055 Crupper Avenue  
Columbus, OH 43229  
(614) 431-3236  
[jellis@nationalboard.org](mailto:jellis@nationalboard.org)

**HIGH EFFICIENCY COMMERCIAL  
POOL PACKAGE SYSTEMS**

# AQUAS™

COMMERCIAL POOL PACKAGE

9 INDOOR & OUTDOOR MODELS FROM  
285,000 TO 850,000 BTU/HR

UP TO 98% THERMAL EFFICIENCY

UP TO 10:1 TURNDOWN RATIO

TITANIUM INDIRECT PLATE AND  
FRAME POOL HEAT EXCHANGER  
ON SELECT MODELS

 **SMART SYSTEM™**  
OPERATING CONTROL



DESIGNED ★ ENGINEERED ★ ASSEMBLED

**USA**

 **Lochinvar®**

### INNOVATION IN DESIGN

The AQUAS commercial pool package is a dramatic advancement in the design of pool heating systems. The AQUAS package is a factory assembled system featuring a free-standing boiler piped to a dedicated titanium pool heat exchanger.

- Effective heat transfer from a high efficiency, modulating condensing boiler.
- A complete factory assembled package reduces installation cost and time.
- Separating the pool water from the direct-fired heat source reduces maintenance and promotes longer equipment life.
- Reliability and performance with a positive user experience.

### POOL HEAT EXCHANGER

A durable industrial grade titanium heat exchanger provides effective heat transfer. The pool water flows through a series of plates. Titanium is a strong but light-weight alloy used in aerospace, automotive and military applications. Used in pool systems, titanium is highly resistant to corrosion from salt water and chlorine. This simple design keeps the pool water separate from the heat source while allowing for complete and highly efficient heat transfer.



### INSIDE THE BOILER

The AQUAS is an innovative pool package that begins with the most advanced boilers in the industry today. The AQUAS heat source is a high efficiency, condensing boiler perfectly suited for the low water temperatures typical of pool heating. The following are some of the exciting features you get with the advanced boiler design.

### FULLY MODULATING BURNER

Modulation is an important combustion feature that is long overdue in the pool industry. Why fire the appliance at 100% input in short bursts to heat the pool water? With a modulating burner, the boiler will tune in the input rate to exactly match the Btu/hr losses of the pool water. The burner will then “cruise” along comfortably, heating the pool water in long, low input burn cycles that dramatically increase the overall life of the boiler.

### THERMAL EFFICIENCY

The AQUAS pool package is constructed with stainless steel modulating condensing boilers that deliver up to 98% thermal efficiency. Low return water temperature from a pool makes for an ideal application. The heat exchanger is sized to maximize the heat transfer of the boiler water to the pool water flowing through the heat exchanger. Higher thermal efficiency reduces your fuel costs.

### DIRECT VENT WITH PVC

Reduce your installation cost and save time and effort by installing the AQUAS pool package with PVC pipe. The AQUAS pool package offers a variety of vent designs in your choice of PVC, CPVC, Polypropylene or Stainless Steel vent material. What’s more, you can Direct Vent the AQUAS. By drawing the combustion air into the appliance with a dedicated intake pipe, the AQUAS is protected from corrosive pool chemicals that could damage the combustion system.

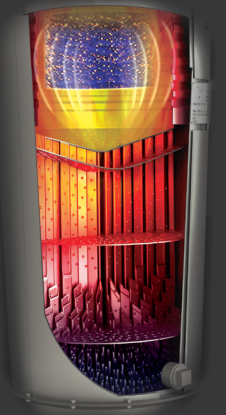



# SMART SYSTEM

*REFINED DESIGN PUTS MORE CONTROL AND INFORMATION AT YOUR FINGERTIPS*

## Just a Few of the Advanced Features:

- MULTI-COLOR GRAPHIC LCD DISPLAY
- NAVIGATION DIAL
- CASCADE OF UP TO 8 AQUAS PACKAGES
- USB PORT FOR PC CONNECTION
- MAINTENANCE REMINDER WITH INSTALLER NAME & NUMBER
- MODBUS COMMUNICATION (OPTIONAL)
- PASSWORD SECURITY
- OPERATIONAL AND ALARM READOUTS

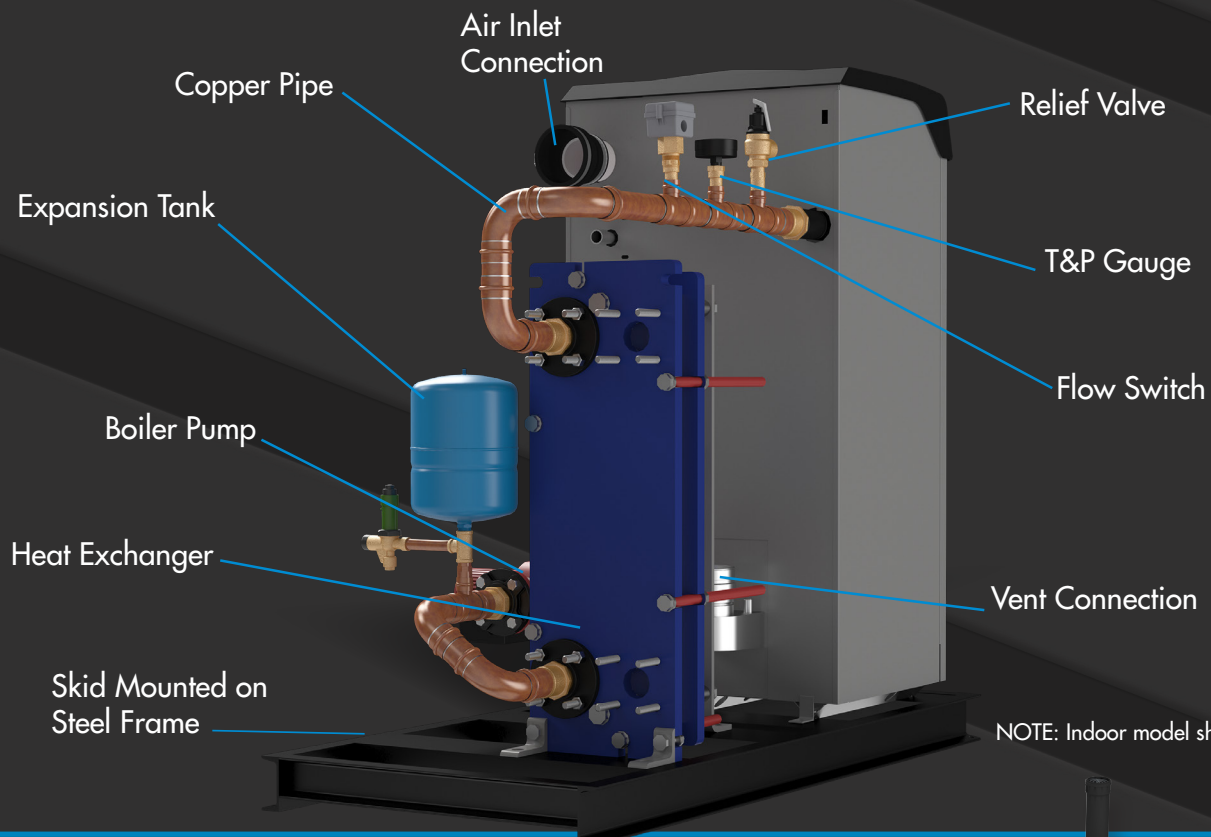
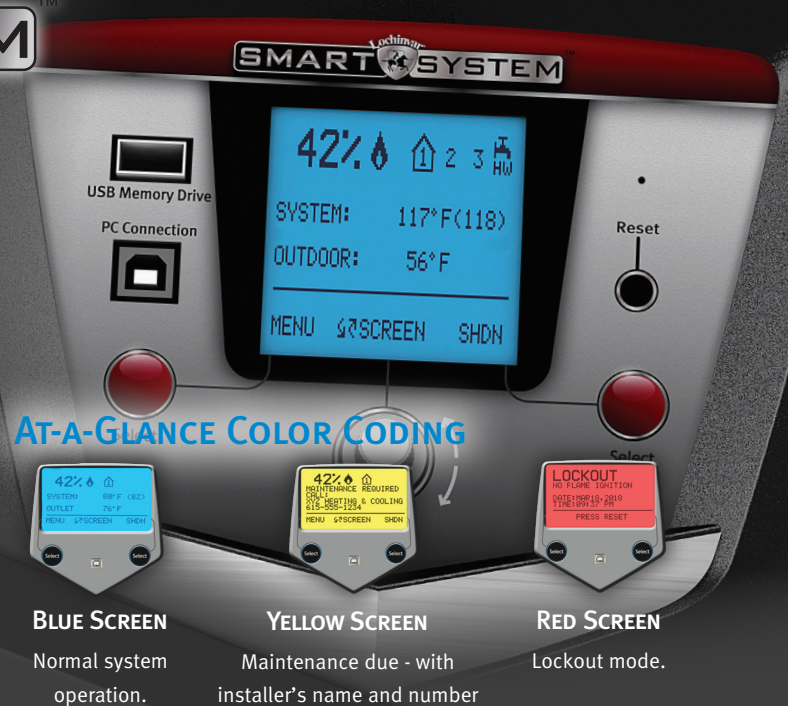

## OUTDOOR RATED MODELS

The AQUAS OXN402-602 models are specially trimmed for outdoor installation. The jacket is sealed and rated to protect the boiler against the elements. Pump covers, air intake covers and a specially-designed vent assembly complete the package to allow for easy installation outdoors.

\*Outdoor models utilize Lochinvar's water tube design heat exchanger and cupro-nickle shell & tube pool heat exchanger. Optional titanium shell and tube pool heat exchanger available.

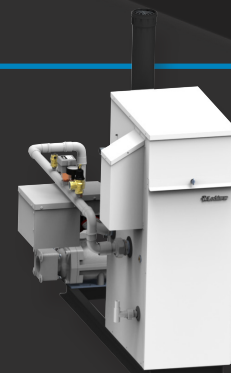

**APN 285**

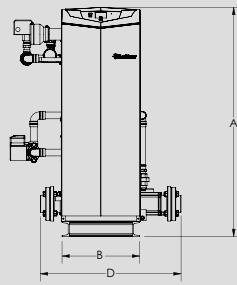
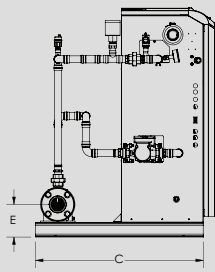

**APN 400 - 850**

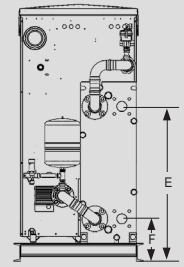
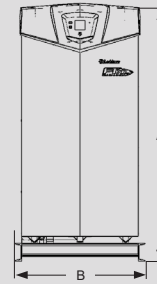
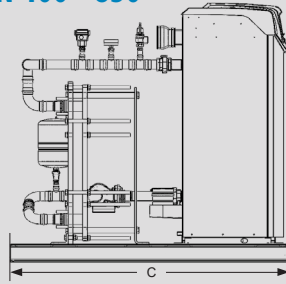

**OXN 402 - 602**

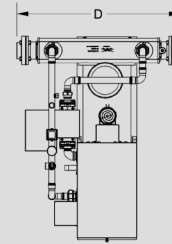
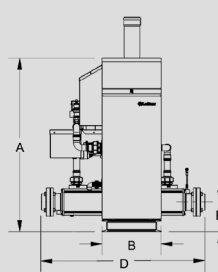
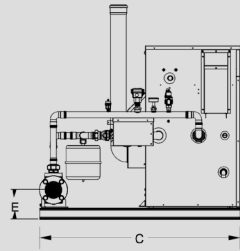

Model Number	Input Btu/hr	Turn Down	A	B	C	D	E	F	Pool Conn.	Gas Conn.	Vent Size	Air Inlet	Pool Flow (GPM)	Ship Wt.
<b>Indoor Models</b>														
APN285	285,000	10:1	46-1/2"	15-3/4"	34"	28-1/2"	6-3/4"	-	2-1/2"	1/2"	3"	3"	68	390
APN400	399,000	10:1	57-1/2"	29-1/4"	62-1/2"	-	34-3/4"	9-1/2"	2"	1"	4"	4"	52	1224
APN500	500,000	10:1	57-1/2"	29-1/4"	62-1/2"	-	34-3/4"	9-1/2"	2"	1"	4"	4"	65	1250
APN600	600,000	7:1	57-1/2"	29-1/4"	62-1/2"	-	34-3/4"	9-1/2"	2"	1"	4"	4"	78	1250
APN725	725,000	7:1	57-1/2"	29-1/4"	62-1/2"	-	35-1/4"	10"	2"	1"	6"	4"	94	1338
APN850	850,000	7:1	57-1/2"	29-1/4"	62-1/2"	-	35-1/4"	10"	2"	1"	6"	4"	90	1367
<b>Outdoor Models</b>														
OXN402	399,000	5:1	45-3/4"	15-3/4"	53"	43-1/4"	7-3/4"	-	2-1/2" or 3"	1"	4"	4"	93	465
OXN502	500,000	5:1	45-3/4"	15-3/4"	57-1/2"	43-1/4"	7-3/4"	-	2-1/2" or 3"	1"	4"	4"	117	497
OXN602	600,000	5:1	46"	15-3/4"	69"	43-1/4"	7-3/4"	-	3"	1"	4"	4"	142	534

Notes: Change 'N' to 'L' for LP gas models. No deration on LP models. Performance data is based on manufacturer test results. Agency certification applies to the boiler.

**STANDARD FEATURES**

- ▶ **Up to 98% Thermal Efficiency**
  - Modulating Burner with up to 10:1 turndown
  - Direct-Spark Ignition
  - Low NOx Operation
  - Sealed Combustion
  - Low Gas Pressure Operation
- ▶ **Vertical & Horizontal Venting**
  - Category IV Venting up to 100 Feet PVC, CPVC
  - Polypropylene or AL29-4C Vent Material
  - Sidewall Vent Terminations Provided (Except APN285)
- ▶ **ASME Stainless Steel Boiler Heat Exchanger**
  - ASME Certified, "H" Stamped
  - Gasketless Design
  - 160 PSI Working Pressure
- ▶ On/Off Switch
- ▶ Expansion Tank w/ Fill Valve
- ▶ Adjustable High Limit w/ Auto Reset
- ▶ Adjustable High Limit w/ Manual Reset
- ▶ Flow Switch
- ▶ Low Air Pressure Switches
- ▶ Inlet & Outlet Temperature Sensors
- ▶ Two Easy Access Terminal Strips
- ▶ Temperature & Pressure Gauge
- ▶ Zero Clearances to Combustible Material
- ▶ ASME Pressure Relief Valve

- ▶ **Titanium Plate & Frame Heat Exchanger** (APN400-850)
  - Salt Water Ready
- ▶ **Titanium Shell & Tube Heat Exchanger** (APN285)
  - Salt Water Ready
  - Flanged CPVC Connections
- ▶ **Cupro-Nickel Pool Shell & Tube Heat Exchanger** (Outdoor Models)
  - Salt Water Ready
  - Flanged CPVC Connections
- ▶ 10 Yr Boiler Warranty (See Warranty for Details)
- ▶ 5 Yr Titanium Pool Heat Exchanger Warranty (See Warranty for Details)
- ▶ 3 Yr Cupro-Nickel Pool Heat Exchanger Warranty (See Warranty for Details)
- ▶ 1 Yr Parts Warranty (See Warranty for Details)

**SMART SYSTEM™ FEATURES**

- ▶ **SMART SYSTEM™ Operating Control**
  - Multi-Colored Graphic LCD Display w/ Navigation Dial
- ▶ **Built in Cascading Sequencer for up to 8 Pool Heaters**
  - Lead Lag
  - Efficiency Optimization
  - Mix multiple input sizes
- ▶ **Building Management System Integration**
  - Optional Modbus communication
  - 0-10 VDC Input Control for Modulation or SetPoint
  - 0-10 VDC Output for Modulation Rate

**OPTIONAL EQUIPMENT**

- ▶ **CON-X-US Remote Connect**
  - Titanium Shell & Tube Pool Heat Exchanger, 5 Yr Warranty (Outdoor Models)
- ▶ Alarm on Any Failure
- ▶ Condensate Neutralization Kit
- ▶ High & Low Gas Pressure Switches w/ Manual Reset
- ▶ Room Air Kit
- ▶ Secondary Heat Exchangers
- ▶ BMS Gateways for LON or BACnet

**FIRING CODES**

- ▶ M9 Standard Construction
- ▶ M7 California Code (APN 285 & Outdoor)
- ▶ M13 CSD1 / Factory Mutual / GE Gap (500-850)

For Ease In Ordering By Model Number

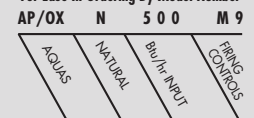

This heater is 500,000 Btu/hr natural gas Pool Heater. It has M9 firing controls.



Lochinvar, LLC  
 300 Maddox Simpson Parkway  
 Lebanon, Tennessee 37090  
 P: 615.889.8900 / F: 615.547.1000  
 f t in y Lochinvar.com



## Jeanne Bock

---

**From:** Kleiss, Jeff <jkleiss@lochinvar.com>  
**Sent:** Monday, May 3, 2021 4:59 PM  
**To:** Don Patten  
**Cc:** Edward Wiggins; Jeanne Bock; melissa.wadkinson@fulton-management.com  
**Subject:** RE: New Interpretation Request for Review  
**Attachments:** APN725-850.pdf

Don,

Yes, this is a package that we build. Attached is a drawing that may be a little more clear.

We have replaced the shell and tube type heat exchanger with the plate and frame heat exchanger on several models. The particular unit that led to this inquiry is our AP\*400. The AP\*400 though AP\*850 share the same type of boiler and use the plate and frame heat exchanger.

Model	Boiler Input, Btu/hr	Boiler water volume, gal	Indirect HEX & Piping Volume, gal	Total Volume, gal
AP*400	399,000	13	4	17
AP*500	500,000	12	4	16
AP*600	600,000	12	4	16
AP*725	725,000	17	4	21
AP*850	850,000	16	4	20

If draining the boiler is required for service, the total volume shown below is what would be drained with no isolation valves installed.

Now if the plate and frame heat exchanger were to be serviced, that would connect to the primary pool loop. We provide instructions to install stop valves between the plate and frame heat exchanger and the primary loop so the heat exchanger can be serviced without draining the system.

Regards,



**Jeff Kleiss**  
*Senior Project Engineer - Certification*

**Lochinvar, LLC**  
 300 Maddox Simpson Parkway • Lebanon, TN  
 P:615.889.8901 X:2224 • [www.Lochinvar.com](http://www.Lochinvar.com)

---

**From:** Don Patten <dpatten@baycityboiler.com>  
**Sent:** Monday, May 3, 2021 2:51 PM  
**To:** Kleiss, Jeff <jkleiss@lochinvar.com>  
**Cc:** Wiggins, Edward F 'Eddie' <edward.wiggins@labor.alabama.gov>; jbock@nationalboard.org; melissa.wadkinson@fulton-management.com  
**Subject:** RE: New Interpretation Request for Review

This message has originated from an **External Source**. Please use proper judgment and caution when opening attachments, clicking links, or responding to this email.

Jeff, if this is a package that Lochinvar builds is it possible to see the drawing in PDF of how it is piped? Also in reviewing the IOM, the instructions on servicing or draining the boiler/heater is not real clear.



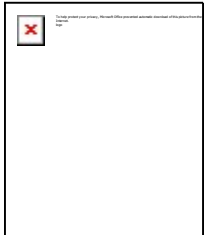



I see that you offer a plate & frame exchanger or shell & tube exchanger.



[\[baycityboiler.com\]](http://baycityboiler.com)

## Don Patten

V.P of Sales

 Office: (510) 786-3711  
 Mobile: (925) 364-1904  
 [dpatten@baycityboiler.com](mailto:dpatten@baycityboiler.com)  
 [www.baycityboiler.com](http://www.baycityboiler.com)  
 [\[baycityboiler.com\]](http://baycityboiler.com)  
 Hayward, Stockton, Fresno

**23312 Cabot Blvd, Hayward, CA  
94545**

[\[facebook.com\]](#)

[\[linkedin.com\]](#)

Sales [\[baycityboiler.com\]](http://baycityboiler.com) | Service [\[baycityboiler.com\]](http://baycityboiler.com) | Parts  
[\[baycityboiler.com\]](http://baycityboiler.com) | Rental [\[baycityboiler.com\]](http://baycityboiler.com) | 24/7  
 Emergency Service [\[baycityboiler.com\]](http://baycityboiler.com)

**From:** Kleiss, Jeff <[jkleiss@lochinvar.com](mailto:jkleiss@lochinvar.com)>

**Sent:** Friday, April 30, 2021 11:04 AM

**To:** Don Patten <[dpatten@baycityboiler.com](mailto:dpatten@baycityboiler.com)>

**Cc:** Wiggins, Edward F 'Eddie' <[edward.wiggins@labor.alabama.gov](mailto:edward.wiggins@labor.alabama.gov)>; [jbock@nationalboard.org](mailto:jbock@nationalboard.org);  
[melissa.wadkinson@fulton-management.com](mailto:melissa.wadkinson@fulton-management.com)

**Subject:** RE: New Interpretation Request for Review

Don,

I don't have photos of the installation but I have attached the brochure for the packages we build showing the piping arrangement on the last page. Will this suffice or would you like me to try to get some pictures from the particular installation?

Regards,



## Jeff Kleiss

*Senior Project Engineer - Certification*

### Lochinvar, LLC

300 Maddox Simpson Parkway • Lebanon, TN  
 P:615.889.8901 X:2224 • [www.Lochinvar.com](http://www.Lochinvar.com)

**From:** Don Patten <[dpatten@baycityboiler.com](mailto:dpatten@baycityboiler.com)>

**Sent:** Friday, April 30, 2021 12:56 PM

To: Kleiss, Jeff <[jkleiss@lochinvar.com](mailto:jkleiss@lochinvar.com)>

Cc: Wiggins, Edward F 'Eddie' <[edward.wiggins@labor.alabama.gov](mailto:edward.wiggins@labor.alabama.gov)>; [jbock@nationalboard.org](mailto:jbock@nationalboard.org);  
[melissa.wadkinson@fulton-management.com](mailto:melissa.wadkinson@fulton-management.com)

Subject: RE: New Interpretation Request for Review



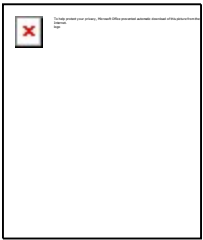

This message has originated from an **External Source**. Please use proper judgment and caution when opening attachments, clicking links, or responding to this email.



[\[baycityboiler.com\]](http://baycityboiler.com)

**Don Patten**

V.P of Sales

-  Office: (510) 786-3711
-  Mobile: (925) 364-1904
-  [dpatten@baycityboiler.com](mailto:dpatten@baycityboiler.com)
-  [www.baycityboiler.com](http://www.baycityboiler.com)
-  [\[baycityboiler.com\]](http://baycityboiler.com)
-  Hayward, Stockton, Fresno

**23312 Cabot Blvd, Hayward, CA 94545**

[\[facebook.com\]](#) [\[linkedin.com\]](#)

Sales [\[baycityboiler.com\]](#) | Service [\[baycityboiler.com\]](#) |  
 Parts [\[baycityboiler.com\]](#) | Rental [\[baycityboiler.com\]](#) |  
 24/7 Emergency Service [\[baycityboiler.com\]](#)

From: NBIC Interpretations Request <[NBICInquiry@nationalboard.org](mailto:NBICInquiry@nationalboard.org)>

Sent: Friday, April 30, 2021 7:43 AM

To: Don Patten <[dpatten@baycityboiler.com](mailto:dpatten@baycityboiler.com)>

Cc: Wiggins, Edward F 'Eddie' <[edward.wiggins@labor.alabama.gov](mailto:edward.wiggins@labor.alabama.gov)>; [jbock@nationalboard.org](mailto:jbock@nationalboard.org);  
[melissa.wadkinson@fulton-management.com](mailto:melissa.wadkinson@fulton-management.com)

Subject: New Interpretation Request for Review

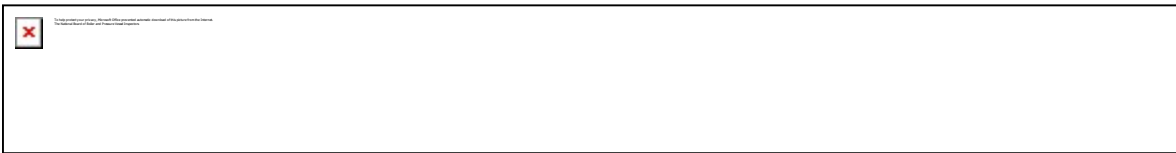

April 30, 2021

Dear Don Patten,

This email is being sent as notification that a new Interpretation Request has been submitted for Subgroup Installation and Subcommittee Installation. Please review the details of the new item below:

Inquirer: Jeff Kleiss  
 Inquirer Contact Email: [jkleiss@lochinvar.com](mailto:jkleiss@lochinvar.com)  
 Phone: +1 (615) 889-8901

Item Number: 21-24 (I)

Item Title: Stop valves on boiler package that is isolated from system water

NBIC Code Section:

<b><u>Part</u></b>	<b><u>Section</u></b>
Installation	3; Paragraph: 3.7.5.1b
Explanation of Need:	A pool heating packaged manufactured by my employer has been rejected by an inspector because there are no stop valves on the supply and return of the boiler. The inspector references NBIC Part 1, 3.7.5.1 b)1). While clause 3.7.5.1 b)2) could provide an exception for use of stop valves, that is only valid when the boiler is located above the associated system piping.
Background Information:	3.7.5.1 b) 1) Stop valves shall be located at an accessible point in the supply and return pipe connections as near as is convenient at practicable, of a single hot water boiler installation to permit draining the boiler without emptying the system. 2) When the boiler is located above the system and can be drained without draining the system stop valves required in NBIC Part 1, 3.7.5.1 b) 1) may be eliminated.
Question:	When a boiler is part of a package with an indirect heat exchanger that isolates the boiler from the primary system water are the stop valves mentioned in NBIC Part 1, 3.7.5.1 b)1) required to be installed on the boiler supply and return?
Proposed Reply:	No.

ave been assigned for this item.

Please contact me if you have any additional questions.

Jonathan Ellis  
 Staff Engineer  
 The National Board of Boiler and Pressure Vessel Inspectors  
 1055 Crupper Avenue  
 Columbus, OH 43229  
 (614) 431-3236  
[jellis@nationalboard.org](mailto:jellis@nationalboard.org)

NOTES (UNLESS OTHERWISE SPECIFIED):

1. PIPING IS COPPER PRO-PRESS
2. \* = ITEM NOT SHOWN

REVISIONS - LAST SAVED: Thursday, July 9, 2020 2:37:05 PM					
REV	DESCRIPTION	PROCESS NO.	CHANGE NO.	DATE	REV BY
A	INITIAL RELEASE	3000035369	500023846	9/26/2019	B. WRIGHT
B	ADD 100286662	3000040212	500028157	6/24/2020	B. WRIGHT

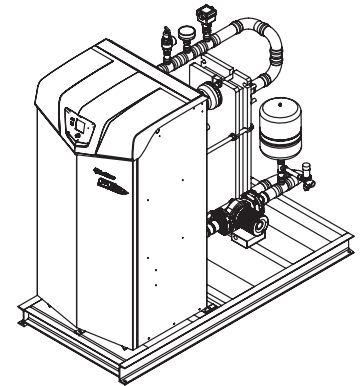
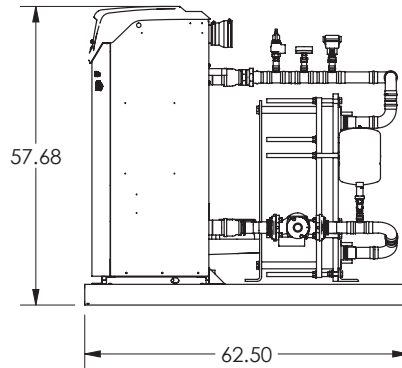
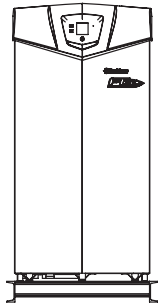
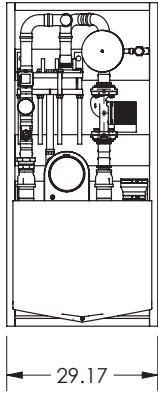

Any Material, Component, Or Vendor Change Must Have Prior Approval By The Applicable Product Engineering Department.		Critical Characteristic For Inspection Purposes:	Dimensions are INCHES Tolerances Unless Otherwise Noted: Angles: ±1° Fractions: ±1/32 Decimals: (2 Pl) ±.03 (3 Pl) ±.005	 <b>A.O. Smith Corporation</b>
Confidential: This drawing and its information are the exclusive and confidential property of A.O. Smith Corp. and are not to be disclosed, duplicated, distributed, or otherwise used without the written consent of A.O. Smith Corp. All rights reserved. ©		Scale: 1:24		
Drawn: <b>B. WRIGHT</b>	Material:	Part Desc: <b>APN725-850</b>		
Date: <b>09/26/2019</b>	Finish:	Part No: <b>SEE TABLE</b>		Sht: 1 Of: 3
DWG / DIR No: <b>2000579238</b>	Ver: <b>01</b>	DWG / DIR Desc: <b>APN725-850</b>		Rev: <b>B</b>

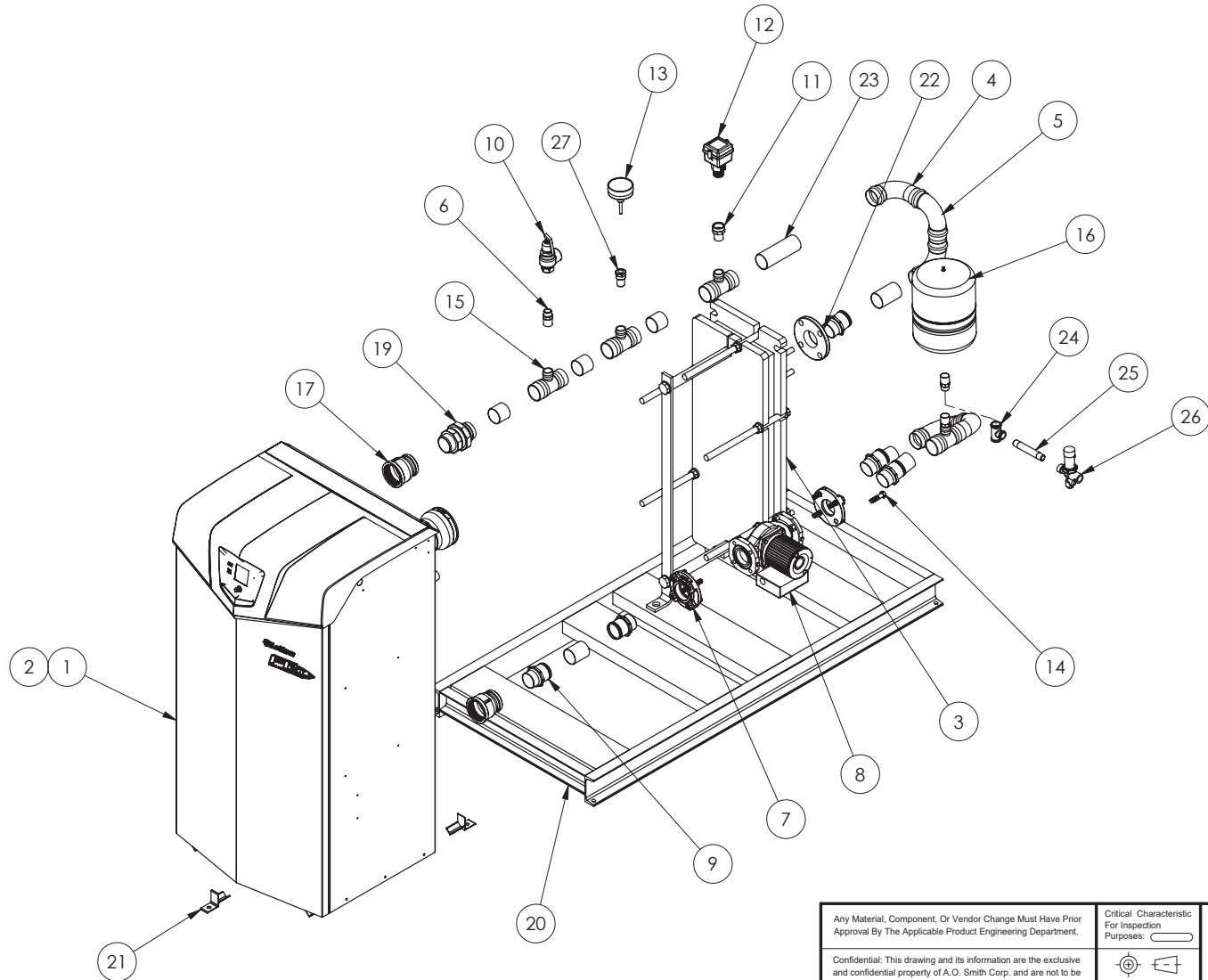

Any Material, Component, Or Vendor Change Must Have Prior Approval By The Applicable Product Engineering Department.		Critical Characteristic For Inspection Purposes:	Dimensions are INCHES	 <b>A.O. Smith Corporation</b>
Confidential: This drawing and its information are the exclusive and confidential property of A.O. Smith Corp. and are not to be disclosed, duplicated, distributed, or otherwise used without the written consent of A.O. Smith Corp. All rights reserved. ©			Tolerances Unless Otherwise Noted: Angles: ±1° Fractions: ±1/32 Decimals: (2 Pl) ±.03 (3 Pl) ±.005	
Scale: 1:14	Drawn: <b>B. WRIGHT</b>	Material:	Part Desc: <b>APN725-850</b>	
Date: 09/26/2019	Finish:	Part No: <b>SEE TABLE</b>		
DWG / DIR No: 2000579238	Ver: 01	DWG / DIR Desc: APN725-850	Shf: 2 Of: 3	Rev: <b>B</b>



**Item Number:** NB11-1901      **NBIC Location:** Part 1      [Attachment Page 1](#)

**General Description:** Add guidance for the safe installation of high pressure composite pressure vessels operating in close proximity to the public

**Subgroup:** FRP

**Task Group:** D. Keeler (PM), J. Eihusen, N. Newhouse

**October Meeting Action:** Mr. Shelley updated the group on discussion from the July 2020 NBIC Subcommittee Installation meeting. This item was originally written for hydrogen vessels, but now other fluid types are included. Subcommittee Installation asked if the language for hydrogen applies to other fluids. An answer to this would be to specify hydrogen and other fluids and generalize the title of the supplement. Then provisions could be added to include other fluids from ASME Section X. Mr. Eihusen and Mr. Newhouse agreed to adjust the proposal to present at the next meeting.

## **NB11-1901**

### **SUPPLEMENT X**

#### **INSTALLATION OF HIGH PRESSURE COMPOSITE PRESSURE VESSELS**

##### **SX.1 SCOPE**

This supplement provides requirements for the installation of high-pressure composite pressure vessels. This supplement is applicable to pressure vessels with an MAWP not exceeding 15,000 psi, and is applicable to the following classes of vessels:

- a) Metallic vessel with a Fiber Reinforced Plastic (FRP) hoop wrap over the shell part of the vessel (both load sharing)
- b) Metallic vessel with a full FRP wrap (both load sharing)
- c) FRP vessel with a non-load sharing metallic liner
- d) FRP vessel with a non-load sharing non-metallic liner

##### **SX.2 SUPPORTS**

Design of supports, foundations, and settings shall consider the dead loads, live loads, wind, and seismic loads. Vibration and thermal expansion shall also be considered. The design of supports, foundations, and settings shall be in accordance with *ASCE/SEI 7, Minimum Design Loads for Buildings and Other Structures*. The importance factors used in calculating the seismic and wind loads shall be the

highest value specified for any category in ASCE/SEI 7.

### **SX.3 CLEARANCES**

The pressure vessel installation shall allow sufficient clearance for normal operation, maintenance, and inspection. Stacking of pressure vessels is permitted. The minimum clear space between pressure vessels shall be 1 ft. vertical and 2 ft. horizontal. Vessel nameplates shall be visible after installation for inspection. The location of vessels containing flammable compressed natural gas fluids shall comply with NFPA 52. The location of vessels containing hydrogen or other flammable fluids shall comply with NFPA 2. The vessel owner shall document the vessel pressure and pipe diameters used as a basis for compliance with NFPA 2 location requirements.

Formatted: Highlight

Formatted: Highlight

### **SX.4 PIPING LOADS**

Piping loads on vessel nozzles shall be determined by a formal flexibility analysis per ASME B31.12: paragraph IP-6.1.5(b). The piping loads shall not exceed the maximum nozzle loads defined by the vessel manufacturer.

### **SX.5 MECHANICAL CONNECTIONS**

Mechanical connections shall comply with pressure vessel manufacturer's instructions, and with requirements of the Jurisdiction. Connections to threaded nozzles shall have primary and secondary seals. The seal design shall include a method for detecting a leak in the primary seal. Seal functionality shall be demonstrated at the initial pressurization of the vessel.

### **SX.6 PRESSURE INDICATING DEVICES**

Each pressure vessel shall be equipped with a pressure gage mounted on the vessel. The dial range shall be from 0 psi to not less than 1.25 times the vessel MAWP. The pressure gage shall have an opening not to exceed 0.0550in (1.4mm) (No. 54 drill size) at the inlet connection. In addition, vessel pressure shall be monitored by a suitable remote pressure indicating device with alarm having an indicating range of 0 psi to not less than 1.25 times the vessel MAWP.

#### **SX.7 PRESSURE RELIEF DEVICES**

Each pressure vessel shall be protected by pressure relief devices per the following requirements:

- a) Pressure relief devices shall be suitable for the intended service.
- b) Pressure relief devices shall be manufactured in accordance with a national or international standard and certified for capacity (or resistance to flow for rupture disk devices) by the National Board.
- c) Dead weight or weighted lever pressure relief valves are prohibited.
- d) Pressure relief valves shall not be fitted with lifting devices.
- e) The pressure relief device shall be installed directly on the pressure vessel with no isolation valves between the vessel and the pressure relief device except:

- 1) When these isolation valves are so constructed or positively controlled below the minimum required capacity, that closing the maximum number of valves at one time will not reduce the pressure relieving capacity, or
- 2) Upon specific acceptance of the Jurisdiction, an isolation valve between vessel and its pressure relief device may be provided for vessel inspection and repair only. The isolation valve shall be arranged so it can be locked or sealed open.
- f) The discharge from pressure relief device(s) shall be directed upward to prevent any impingement of escaping fluid upon the vessel, adjacent vessels, adjacent structures, or personnel. The discharge must be to outdoors, not under any structure or roof that might permit formation of a "cloud". The pressure relief device(s) discharge piping shall be designed so that it cannot become plugged by animals, insects, rainwater, or other materials.
- g) When a single pressure relieving device is used, it shall be set to operate at a pressure not exceeding the MAWP of the vessel. When the required capacity is provided in more than one pressure relieving device, only one device need be set at or below the MAWP, and the additional device(s) may be set to open at higher pressures but in no case at a pressure higher than 105% of the MAWP. The requirements of RR-130 of ASME Section X shall also apply.

- h) The pressure relief device(s) shall have sufficient capacity to ensure the pressure vessel does not exceed the MAWP of that specified in the original code of construction.
- i) The owner shall document the basis for selection of the pressure relief device(s) used, including capacity.
- j) The owner shall have such analysis available for review by the Jurisdiction.
- k) Pressure relief devices and discharge piping shall be supported so that reaction forces are not transmitted to the vessel.
- l) Heat detection system: a heat activated system shall be provided so that vessel contents will be vented per f) (above), if any part of the vessel is exposed to a temperature greater than 220°F.
- m) Positive methods shall be incorporated to prevent overfilling of the vessel.

**SX.8 ASSESSMENT OF INSTALLATION**

- a) Isolation valve(s) shall be installed directly on each vessel, but not between the vessel and the pressure relief device except as noted in 3.7, e), above.
- b) Vessels shall not be buried.

c) Vessels may be installed in a vault subject to a hazard analysis, verified by the manufacturer, owner, user, qualified engineer, or the Jurisdiction, to include as a minimum the following:

- 1) Ventilation
- 2) Inlet and outlet openings
- 3) Access to vessels
- 4) Clearances
- 5) Intrusion of ground water
- 6) Designed for cover loads
- 7) Explosion control
- 8) Ignition sources
- 9) Noncombustible construction
- 10) Remote monitoring for leaks, smoke, and fire
- 11) Remote controlled isolation valves

d) Fire and heat detection/suppression provisions shall comply with the requirements of the Jurisdiction and, as a minimum, include relief scenarios in the event of a fire or impending overpressure from heat sources.

e) Installation locations shall provide the following:

- 1) Guard posts shall be provided to protect the vessels from vehicular damage per NFPA 2 or NFPA 52, as appropriate.

Formatted: Highlight

Protection from wind, seismic events shall be provided.

- 2) Supports and barriers shall be constructed of non-combustible materials.

- 3) Vessels shall be protected from degradation due to direct sunlight.

- 4) Access to vessels shall be limited to authorized personnel.

- 5) Any fence surrounding the vessels shall be provided with a minimum of two gates. The gates shall open outward, and shall be capable of being opened from the inside without a key.

- 6) Access for initial and periodic visual inspection and NDE of vessels, supports, piping, pressure gages or devices, relief devices and related piping, and other associated equipment.

- 7) Completed installations shall be validated as required by the Jurisdiction as addressing all of the above, and any requirements of the Jurisdiction, prior to first use. This verification shall be posted in a conspicuous location near the vessel and, when required, on file with the



Jurisdiction. Certificates shall be updated as required by mandated subsequent inspections.

8) Piping installation shall comply with ASME B31.12, NFPA 52, or NFPA 2.

Formatted: Highlight

9) The vessels shall be electrically bonded and grounded per NFPA 55.

**SX.9 LADDERS AND RUNWAYS**

See NBIC Part 1, Section 1.6.4 *Ladders and Runways*

Item 20-27

## Supplement 10

### Installation of Carbon Monoxide Detectors in Boiler Rooms

#### S10.1 Scope

This supplement provides guidelines for the installation of carbon monoxide (CO) detectors/alarms in fuel fired equipment rooms.

Carbon Monoxide (CO) is a ~~poisonous~~toxic, colorless, odorless and tasteless gas that can cause injury and even death if not detected. Statistics show about 400 deaths and 10,000 hospitalizations each year from non-fire related CO incidents. High levels of CO can be an indication of poor combustion leading to inefficient operation resulting in increased fuel usage and emissions or improperly installed or corroded flue piping.

All boiler mechanical rooms containing one or more boilers and/or pressure vessels from which carbon monoxide can be produced should be equipped with a carbon monoxide detector that can meet the criteria below.

#### S10.2 General Requirements for Installation of Carbon Monoxide Detector

It is recommended a carbon monoxide detector and any PRI that can produce CO should be interlocked to stop the production of CO by disabling all equipment capable of producing CO in the space the equipment is installed.

(a) (C) The CO Detector should be interlocked to disable all PRI's capable of producing CO in the space the PRI is installed when the detector trips.

(A) CO Detectors without remote monitoring in the space where CO is capable of being produced.

(1) The CO Detector should be of the manual reset type

(2) The CO Detector should set to alarm and trip at 50 PPM.

(B) CO Detectors provided with remote monitoring in the space where CO is capable of being produced.

(1) The CO Detector should be of the manual reset type.

(2) The CO Detector should be set to alarm at 50 PPM

**Commented [JE1]:** NOTE: this is the max level permitted by OSHA, see attached OSHA document.

Item 20-27

(3) The CO Detector should set to trip at 200 PPM.

(c) When the CO Detector trips in (a) or (b) above, the detector should be interlocked with all PRI's installed in the space to secure the PRI's, thus stopping the production of CO.

(d) The carbon monoxide detector should be calibrated in accordance with the manufacturer's recommendations or every eighteen months after installation of the detector. A record of calibration should be identified on the CO Detector.

**Commented [JE2]:** NOTE: this is the max level permitted by OSHA with roll-on and roll-off operating during cargo loading and unloading, see attached OSHA document.

Item 20-27

Initial installation and calibration should be performed in accordance with the manufacturers requirements. Subsequent inspections should be performed in accordance with recognized industry or regulatory standards.

KEY EXCERPTS FROM NFPA 720

- 5.8.5.3.3 Carbon Monoxide detectors shall be marked in accordance with their listing. Detector thresholds shall be set to respond at the levels specified by ANSI/UL2034, Standard for Single and Multiple Station Monoxide Alarms.
- 5.8.5.3.4 All carbon monoxide detectors shall be located and mounted so that accidental operation will not be caused by jarring or vibration.
- 5.8.5.3.5 The location of carbon monoxide detectors shall be based on an evaluation of potential ambient sources and flows of carbon monoxide, moisture, temperature, dust, or fumes and of electrical influences to minimize nuisance alarms [72: 17.7.1.9]
- 5.8.5.3.6 The selection and placement of [carbon monoxide] detectors shall take into account both the performance characteristics of the detector and the areas into which the detectors are to be installed to prevent nuisance and unintentional alarms or improper operation after installation [72: 17.7.1.7]

Single and Multiple Station Carbon Monoxide Alarms

UL 2034

1 Scope

1.1 These requirements cover electrically operated single and multiple station carbon monoxide (CO) alarms intended for protection in ordinary indoor locations of dwelling units, including recreational vehicles, mobile homes, and recreational boats with enclosed accommodation spaces and cockpit areas.

## Carbon Monoxide Poisoning

**Carbon monoxide (CO) is a poisonous, colorless, odorless and tasteless gas. Although it has no detectable odor, CO is often mixed with other gases that do have an odor. So, you can inhale carbon monoxide right along with gases that you can smell and not even know that CO is present.**

**CO is a common industrial hazard resulting from the incomplete burning of material containing carbon such as natural gas, gasoline, kerosene, oil, propane, coal, or wood. Forges, blast furnaces and coke ovens produce CO, but one of the most common sources of exposure in the workplace is the internal combustion engine.**

### How does CO harm you?

Carbon monoxide is harmful when breathed because it displaces oxygen in the blood and deprives the heart, brain and other vital organs of oxygen. Large amounts of CO can overcome you in minutes without warning — causing you to lose consciousness and suffocate.

Besides tightness across the chest, initial symptoms of CO poisoning may include headache, fatigue, dizziness, drowsiness, or nausea. Sudden chest pain may occur in people with angina. During prolonged or high exposures, symptoms may worsen and include vomiting, confusion and collapse in addition to loss of consciousness and muscle weakness. Symptoms can vary widely from person to person. CO poisoning may occur sooner in those most susceptible: young children, the elderly, people with lung or heart disease, people at high altitudes, or those who already have elevated CO blood levels, such as smokers. Also, CO poisoning poses a special risk to fetuses.

CO poisoning can be reversed if caught in time. But even if you recover, acute poisoning may result in permanent damage to the parts of your body that require a lot of oxygen such as the heart and brain. Significant reproductive risk is also linked to CO.

### Who is at risk?

You may be exposed to harmful levels of CO in boiler rooms, warehouses, petroleum refineries, pulp and paper production, and steel production; around docks, blast furnaces, or coke ovens; or in one of the following occupations:

- Welder
- Garage mechanic
- Firefighter
- Carbon-black maker
- Organic chemical synthesizer
- Metal oxide reducer
- Longshore worker
- Diesel engine operator
- Forklift operator
- Marine terminal worker
- Toll booth or tunnel attendant
- Customs inspector
- Police officer
- Taxi driver

### What can you do if you suspect that someone has been poisoned with CO?

When you suspect CO poisoning, promptly taking the following actions can save lives:

- Move the victim immediately to fresh air in an open area.
- Call 911 or another local emergency number for medical attention or assistance.
- Administer 100 percent oxygen using a tight-fitting mask if the victim is breathing.

- Administer cardiopulmonary resuscitation if the victim has stopped breathing.

**Warning:** You may be exposed to fatal levels of CO poisoning in a rescue attempt. Rescuers should be skilled at performing recovery operations and using recovery equipment. Employers should make sure that rescuers are not exposed to dangerous CO levels when performing rescue operations.

### How can employers help prevent CO poisoning?

To reduce the chances of CO poisoning in the workplace, employers should take the following actions:

- Install an effective ventilation system that will remove CO from work areas.
- Maintain equipment and appliances (e.g., water heaters, space heaters, cooking ranges) that can produce CO in good working order to promote their safe operation and to reduce CO formation.
- Consider switching from gasoline-powered equipment to equipment powered by electricity, batteries, or compressed air if it can be used safely.
- Prohibit the use of gasoline-powered engines or tools in poorly ventilated areas.
- Provide personal CO monitors with audible alarms if potential exposure to CO exists.
- Test air regularly in areas where CO may be present, including confined spaces. See Title 29 of the Code of Federal Regulations (CFR) 1910.146.
- Use a full-facepiece pressure-demand self-contained breathing apparatus (SCBA) certified by the National Institute for Occupational Safety and Health (NIOSH), or a combination full-facepiece pressure demand supplied-air respirator with auxiliary self-contained air supply in areas with high CO concentrations, i.e., those with immediately dangerous to life and health atmospheres. (See 29 CFR 1910.134.)
- Use respirators with appropriate canisters, in conjunction with personal CO monitoring, for short periods under certain circumstances where CO levels are not exceedingly high.
- Educate workers about the sources and conditions that may result in CO poisoning as well as the symptoms and control of CO exposure.

In addition, if your employees are working in confined spaces where the presence of CO is suspected, you must ensure that workers test for oxygen sufficiency before entering.

### What can employees do to help prevent CO poisoning?

Employees should do the following to reduce the chances of CO poisoning in the workplace:

- Report any situation to your employer that might cause CO to accumulate.
- Be alert to ventilation problems — especially in enclosed areas where gases of burning fuels may be released.
- Report promptly complaints of dizziness, drowsiness, or nausea.
- Avoid overexertion if you suspect CO poisoning and leave the contaminated area.
- Tell your doctor that you may have been exposed to CO if you get sick.
- Avoid the use of gas-powered engines, such as those in powered washers as well as heaters and forklifts, while working in enclosed spaces.

### What are the OSHA standards for CO exposure?

- The OSHA PEL for CO is 50 parts per million (ppm). OSHA standards prohibit worker exposure to more than 50 parts of CO gas per million parts of air averaged during an 8-hour time period.
- The 8-hour PEL for CO in maritime operations is also 50 ppm. Maritime workers, however, must be removed from exposure if the CO concentration in the atmosphere exceeds 100 ppm. The peak CO level for employees engaged in Ro-Ro operations (roll-on roll-off operations during cargo loading and unloading) is 200 ppm.

### Workers' Rights

Workers have the right to:

- Working conditions that do not pose a risk of serious harm.
- Receive information and training (in a language and vocabulary the worker understands) about workplace hazards, methods to prevent them, and the OSHA standards that apply to their workplace.
- Review records of work-related injuries and illnesses.

- File a complaint asking OSHA to inspect their workplace if they believe there is a serious hazard or that their employer is not following OSHA's rules. OSHA will keep all identities confidential.
- Exercise their rights under the law without retaliation, including reporting an injury or raising health and safety concerns with their employer or OSHA. If a worker has been retaliated against for using their rights, they must file a complaint with OSHA as soon as possible, but no later than 30 days.

For additional information, see OSHA's Workers page ([www.osha.gov/workers](http://www.osha.gov/workers)).

### How to Contact OSHA

Under the Occupational Safety and Health Act of 1970, employers are responsible for providing safe and healthful workplaces for their employees. OSHA's role is to help ensure these conditions for America's working men and women by setting and enforcing standards, and providing training, education and assistance. For more information, visit [www.osha.gov](http://www.osha.gov) or call OSHA at 1-800-321-OSHA (6742), TTY 1-877-889-5627.

**This is one in a series of informational fact sheets highlighting OSHA programs, policies or standards. It does not impose any new compliance requirements. For a comprehensive list of compliance requirements of OSHA standards or regulations, refer to Title 29 of the Code of Federal Regulations. This information will be made available to sensory-impaired individuals upon request. The voice phone is (202) 693-1999; teletypewriter (TTY) number: (877) 889-5627.**



U.S. Department of Labor



DSG FS-3522 04/2012

## SECTION 915 CARBON MONOXIDE DETECTION

### [F]915.1 General.

#### CDP

Carbon monoxide detection shall be installed in new buildings in accordance with [Sections 915.1.1](#) through [915.6](#). Carbon monoxide detection shall be installed in existing buildings in accordance with [Chapter 11](#) of the *International Fire Code*.

### [F]915.1.1 Where required.

Carbon monoxide detection shall be provided in Group I-1, I-2, I-4 and R occupancies and in classrooms in Group E occupancies in the locations specified in [Section 915.2](#) where any of the conditions in [Sections 915.1.2](#) through [915.1.6](#) exist.

### [F]915.1.2 Fuel-burning appliances and fuel-burning fireplaces.

Carbon monoxide detection shall be provided in *dwelling units*, *sleeping units* and classrooms that contain a fuel-burning appliance or a fuel-burning fireplace.

### [F]915.1.3 Fuel burning, forced-air furnaces.

Carbon monoxide detection shall be provided in dwelling units, sleeping units and classrooms served by a fuel-burning, forced-air furnace.

**Exception:** Carbon monoxide detection shall not be required in *dwelling units*, *sleeping units* and classrooms if a carbon monoxide detector is provided in the first room or area served by each main duct leaving the furnace, and the carbon monoxide alarm signals are automatically transmitted to an approved location.

### [F]915.1.4 Fuel-burning appliances outside of dwelling units, sleeping units and classrooms.

Carbon monoxide detection shall be provided in *dwelling units*, *sleeping units* and classrooms located in buildings that contain fuel-burning appliances or fuel-burning fireplaces.

#### Exceptions:

1. Carbon monoxide detection shall not be required in *dwelling units*, *sleeping units* and classrooms without communicating openings between the fuel-burning appliance or fuel-burning fireplace and the *dwelling unit*, *sleeping unit* or classroom.
2. Carbon monoxide detection shall not be required in *dwelling units*, *sleeping units* and classrooms where a carbon monoxide detector is provided in one of the following locations:
  - 2.1. In an *approved* location between the fuel-burning appliance or fuel-burning fireplace and the *dwelling unit*, *sleeping unit* or classroom.
  - 2.2. On the ceiling of the room containing the fuel-burning appliance or fuel-burning fireplace.

### [F]915.1.5 Private garages.

Carbon monoxide detection shall be provided in *dwelling units*, *sleeping units* and classrooms in buildings with attached *private garages*.

#### Exceptions:



1. Carbon monoxide detection shall not be required in dwelling units, sleeping units and classrooms without communicating openings between the *private garage* and the *dwelling unit*, *sleeping unit* or classroom.
2. Carbon monoxide detection shall not be required in *dwelling units*, *sleeping units* and classrooms located more than one *story* above or below a *private garage*.
3. Carbon monoxide detection shall not be required where the *private garage* connects to the building through an *open-ended corridor*.
4. Where a carbon monoxide detector is provided in an *approved* location between openings to a *private garage* and *dwelling units*, *sleeping units* or classrooms.

**[F]915.1.6 Exempt garages.**

For determining compliance with [Section 915.1.5](#), an *open parking garage* complying with [Section 406.5](#) or an enclosed parking garage complying with [Section 406.6](#) shall not be considered a *private garage*.

**[F]915.2 Locations.**

Where required by [Section 915.1.1](#), carbon monoxide detection shall be installed in the locations specified in [Sections 915.2.1](#) through [915.2.3](#).

**[F]915.2.1 Dwelling units.**

Carbon monoxide detection shall be installed in *dwelling units* outside of each separate sleeping area in the immediate vicinity of the bedrooms. Where a fuel-burning appliance is located within a bedroom or its attached bathroom, carbon monoxide detection shall be installed within the bedroom.

**[F]915.2.2 Sleeping units.**

**CDP**

Carbon monoxide detection shall be installed in *sleeping units*.

**Exception:** Carbon monoxide detection shall be allowed to be installed outside of each separate sleeping area in the immediate vicinity of the *sleeping unit* where the *sleeping unit* or its attached bathroom does not contain a fuel-burning appliance and is not served by a forced air furnace.

**[F]915.2.3 Group E occupancies.**

Carbon monoxide detectors shall be installed in classrooms in Group E occupancies. Carbon monoxide alarm signals shall be automatically transmitted to an on-site location that is staffed by school personnel.

**Exception:** Carbon monoxide alarm signals shall not be required to be automatically transmitted to an on-site location that is staffed by school personnel in Group E occupancies with an *occupant load* of 30 or less.

**[F]915.3 Carbon monoxide detection.**

Carbon monoxide detection required by [Sections 915.1](#) through [915.2.3](#) shall be provided by carbon monoxide alarms complying with [Section 915.4](#) or carbon monoxide detection systems complying with [Section 915.5](#).

**[F]915.4 Carbon monoxide alarms.**

Carbon monoxide alarms shall comply with [Sections 915.4.1](#) through [915.4.4](#).

**[F]915.4.1 Power source.**

Carbon monoxide alarms shall receive their primary power from the building wiring where such wiring is served from a commercial source, and when primary power is interrupted, shall receive power from a battery. Wiring shall be permanent and without a disconnecting switch other than that required for overcurrent protection.

**Exception:** Where installed in buildings without commercial power, battery-powered carbon monoxide alarms shall be an acceptable alternative.

**[F]915.4.2 Listings.**

Carbon monoxide alarms shall be listed in accordance with [UL 2034](#).

**[F]915.4.3 Locations.**

Carbon monoxide alarms shall only be installed in *dwelling units* and in *sleeping units*. They shall not be installed in locations where the code requires carbon monoxide detectors to be used.

**[F]915.4.4 Combination alarms.**

Combination carbon monoxide/smoke alarms shall be an acceptable alternative to carbon monoxide alarms. Combination carbon monoxide/smoke alarms shall be listed in accordance with [UL 217](#) and [UL 2034](#).

**[F]915.5 Carbon monoxide detection systems.**

**CDP**

Carbon monoxide detection systems shall be an acceptable alternative to carbon monoxide alarms and shall comply with [Sections 915.5.1](#) through [915.5.3](#).

**[F]915.5.1 General.**

**CDP**

Carbon monoxide detection systems shall comply with [NFPA 720](#). Carbon monoxide detectors shall be *listed* in accordance with [UL 2075](#).

**[F]915.5.2 Locations.**

**CDP**

Carbon monoxide detectors shall be installed in the locations specified in [Section 915.2](#). These locations supersede the locations specified in [NFPA 720](#).

**[F]915.5.3 Combination detectors.**

**CDP**

Combination carbon monoxide/smoke detectors installed in carbon monoxide detection systems shall be an acceptable alternative to carbon monoxide detectors, provided that they are listed in accordance with [UL 268](#) and [UL 2075](#).

**[F]915.6 Maintenance.**

Carbon monoxide alarms and carbon monoxide detection systems shall be maintained in accordance with the [International Fire Code](#).

Item 20-34 (merged with 20-35, 20-40)

July 2021 - NBIC Part 1

## ITEM 20-34, 20-35 (and 20-40) COMBINED

**PROPOSED CHANGES –** The following proposal is based on the comments recorded during the R&C ballot. Comments show where the changes were incorporated or felt they were already addressed. All comments are presented in the background information.

## 1.6.5 FUEL

All fuel systems shall be installed in accordance with jurisdictional and environmental requirements, manufacturer's recommendations, and/or industry standards, such as ASME CSD-1, ANSI Z/CSA, NFPA 85 or others, as applicable.

a) Natural Gas1) Cleaning

- a. It is recommended that strainers be installed in the main gas line leading to the boiler control equipment.
- b. A sediment trap is required prior to the gas controls. This trap shall be located in a vertical section of pipe as close as practical upstream of the gas controls.

2) Manual Valves

- a. A manual valve is required upstream of all controls and as close as practical to the boiler to isolate the fuel train when required. If a pilot line is upstream of the manual valve on the main fuel train, it shall also have a manual valve.
- b. These manual valves shall be accessible from the floor and designed to be opened/closed without additional tools. They shall be ball or a lubricated plug type with a non-removable handle that is perpendicular to the gas flow when closed and parallel when open and the valves shall have stops.
- c. If the non-removable handle creates a hazard, the handle can be temporarily removed provided the valve handle is always on while the valve is in the open position. At all times, the position of the valve shall be indicated. When the valve is in the closed position and the handle is not attached, the valve shall be tagged/locked out and the handle shall be tethered and accessible.
- d. If the valve is not part of a listed and labeled assembly, the valve shall comply with a nationally recognized standard.

3) Vents

For gas components that are vented or bled, the following requirements apply:

- a. All vent or bleed lines from natural gas equipment such as regulators, controls, switches, relief, vent valves, etc. shall be vented outside to a safe point of discharge per the manufacturer's requirements or the authority having jurisdiction.
- b. Vent and bleed line shall be sized in accordance with a nationally recognized standard.
- c. Manifold of vent lines or of bleed lines shall be in accordance with a nationally recognized standard. Vent lines shall not be manifolded with bleed lines.

**Commented [JP-H1]:** Ms. Wadkinson asked if we should include " or in accordance with the manufacturer's instructions?". This language was existing. Do we feel this is sufficient?

**Commented [JP-H2]:** Deleted a repetitively redundant "applicable" per Mr. Wiggins comment.

**Commented [JP-H3]:** This was added to address Mr. Pattens comment.

He noted that not some regulators, gas valves and switches are certified as ventless.

**Commented [JP-H4]:** Related to Ms. Wadkinson's comment. This could be considered redundant to the introductory "manufacturer's recommendation, but

I recommend keeping it, because this is the type of place where a MFR recommendation would be useful.

I did change "per the requirements of the manufacturer" to "per the manufacturer's requirements".

Item 20-34 (merged with 20-35, 20-40)

July 2021 - NBIC Part 1

- d. No vent or bleed line shall discharge into a flue.
- e. Vent materials shall be selected such that they shall have suitable strength and durability for their intended purpose and shall be listed for the intended purpose by the jurisdiction having authority or a nationally recognized standard.

b) Fuel Oil -

A strainer or filter shall be installed upstream of the safetyshutoff valves.

**Commented [JP-H5]:** For clarity, Item 20-35 was closed and the actions incorporated into item 20-34.

**BACKGROUND INFORMATION**

Comments to R&amp;C ballot 4-22 to 05/21 2021

## 1) Don Patten

<b>Committee Member:</b>	Don Patten	<b>Vote Date:</b>	2021-04-29	<b>Vote:</b>	Approved	<b>Uploads:</b>	_____
<b>Member Comment:</b>	See below information. Something needs to be inserted in 3) Vents allowing for ventless gas components & trains. Exception: A regulator and vent limiting means combination listed as complying with ANSI Z21.80/CSA 6.22, Line Pressure Regulators, shall be permitted to be used without a vent to the outdoors. Also some gas valves and switches are certified as ventless (Siemens, Dungs, etc.).						
<b>PM Reply:</b>	Thank you for the comment. You are correct, there are many components that don't require vents. We already reference national standards in the opening, so perhaps an introductory statement such as the following would suffice:  For gas components that are vented, the following requirements apply:						

## 2) Melissa Wadkinson

<b>Committee Member:</b>	Melissa Wadkinson	<b>Vote Date:</b>	2021-05-19	<b>Vote:</b>	Approved	<b>Uploads:</b>	_____
<b>Member Comment:</b>	I'll approve this but upon reading do we want to add some language "or in accordance with the manufacturer's instructions"?						
<b>PM Reply:</b>	Thank you for the comment and support. In the lead paragraph of 1.6.5, the existing words include manufacturer's recommendations.  "All fuel systems shall be installed in accordance with jurisdictional and environmental requirements, manufacturer's recommendations, and/or industry standards, such as....."  Everything added regarding Natural Gas is a subset to the lead in, so I believe that it is already covered. This raises a good question however. There is no guidance on how to resolve a conflict between the NBIC and the manufacturer's recommendation however.						

## 3) Eddie Wiggins

## 1.6.5 FUEL

All fuel systems shall be installed in accordance with jurisdictional and environmental requirements, manufacturer's recommendations, and/or industry standards, such as ASME CSD-1, applicable ANSI Z/CSA, NFPA 85 or others as applicable.

WE

**Wiggins, Edward F 'Eddie'**  
Pat, should this be removed due to it being the last word of the sentence?

## 4) H. Michael Richards

Item 20-34 (merged with 20-35, 20-40)

July 2021 - NBIC Part 1

<b>Committee Member:</b>	H. Michael Richards	<b>Vote Date:</b>	2021-05-12	<b>Vote:</b>	Approved	<b>Uploads:</b>	
<b>Member Comment:</b>	As edited 5/12/2021						
<b>PM Reply:</b>	Mr. Richards. I am sorry, but I don't understand your comment.						

**REVIEW – The following is the original review that led to the above.**

NBIC part 1 addresses fuel for all boilers in 1.6.5. Controls are part of 2.5.3.3 and 3.5.3.3. The intent here is to address fuel train related items. It does not make sense to break up the equipment between fuel supply equipment (sediment trap, shutoff valves) and the controls equipment (vents). They are fuel related equipment, so the new requirements should be located in 1.6.5.

FOLLOWING is the Review of CSD-1 and what was suggested in the January 20 meeting.

CF - 120

<u>CSD – 1 Summary</u>	<u>NBIC – Yes/No and words.</u>	<u>Should it cover</u>
CF-120 – Fuel Train		
a) Non-mandatory appendix provides typical fuel train examples. Fuel trains other than those pictured, but meeting the standard shall be permitted.	<p>Following are the current wording in NBIC.</p> <p>1.4.5.1.1 Guide for Completing National Board Boiler Installation Report</p> <p>40) External Piping ASME CODE AND FUEL TRAIN: Indicate if external piping is ASME Code, if not, indicate what code or standard external piping is manufactured to. Indicate if the fuel train meets the requirements of CSD-1 or...</p> <p>1.6.5 Fuel – All fuel systems shall be installed in accordance with jurisdictional and environmental requirements, manufacturer's recommendations, and/or industry standards, such as ASME CSD-1, applicable ANSI Z/CSA, NFPA 85 or others as applicable.</p>	YES

Item 20-34 (merged with 20-35, 20-40)

July 2021 - NBIC Part 1

	<p style="color: red;">Fuel train component requirements will be based on the standard, fuel fired and the heat input.</p> <p>2.5.2 Fuel</p> <p style="padding-left: 40px;">See NBIC Part 1, Section 1.6.5, <i>Fuel</i>.</p> <p>2.5.3.3 and 3.5.3.3 – Controls and Heat-Generating Apparatus</p> <p>a) Oil and gas-fired and electrically heated boilers shall be equipped with suitable primary (flame safeguard) safety controls, safety limit switches and controls, and burners or electric elements as required by a nationally or internationally recognized standard.</p> <p>b) The symbol of the certifying organization that has investigated such equipment as having complied with a nationally recognized standard shall be affixed to the equipment and shall be considered as evidence that the unit was manufactured in accordance with that standard.</p> <p>c) These devices shall be installed in accordance with jurisdictional and environmental requirements, manufacturer's recommendations, and/or industry standards, as applicable.</p> <p>3.5.2 Fuel</p> <p style="padding-left: 40px;">See NBIC Part 1, Section 1.6.5, <i>Fuel</i>.</p>	
<p>c) Thread sealing compound resistant to LPG</p>	<p>No mention of thread sealing compound, etc. in NBIC Part 1, Installation.</p>	<p style="color: red;">No.</p>

CF-130 – Filters or Strainers

<u>CSD – 1 Summary</u>	<u>NBIC – Yes/No and words.</u>	<u>Should it cover</u>
CF-130 – Filters or Strainers		

Item 20-34 (merged with 20-35, 20-40)

July 2021 - NBIC Part 1

Filters or strainers are recommended in the main gas supply line.	Not mentioned.	Yes.
---	----------------	------

## CF-140 – Sediment Traps and Drips

<u>CSD – 1 Summary</u>	<u>NBIC – Yes/No and words.</u>	<u>Should it cover</u>
CF-140 – Sediment Traps and Drips		
a) A sediment trap shall be installed before the controls. On a vertical. Manufacture supplies or specifies that the sediment trap is installed as close as practicable to the controls.	Also covered in NFGC NFPA 54  No mention of sediment traps and drips in NBIC Part 1, Installation.	Yes
b) If the gas is not dry, a drip shall be provided at any point where condensate could collect.	No – How do we know if its wet or dry	No

## CF-150 Manually Operated Gas shutoff valves

CF-150 Manually operated gas shutoff valves	Not currently –	Yes
a) Unless provided as part of an assembly, each valve shall comply with ANSI, CSA, UL or a nationally recognized standard and be suitable	Manually operated gas shutoff valves shall be provided and comply with a national standard and a symbol.....	
b) Manual shutoff valves shall be ball or lubricated plug type with stops.	Gas shut off valves shall be ball or lubricated plug type	Yes
c) Manually operated valves shall be T-handle or lever-handled with handle parallel to the gas flow when open and perpendicular when closed. Valve shall be accessible and indicate open/closed. Adequate size to be operated without using tools. Maintained and exercised in accordance with manufacturer's instructions.	Handles attached so the handle is parallel when open and perpendicular when closed.  Valve shall be accessible and indicate open/closed. Adequate size.	Yes
d) Except as allowed in e) below the handle shall be permanently attached.	Similar to CF-150 d) and e)  Handle permanently attached unless it creates a hazard. Handle can be temporarily (must be reattached before operator leaves) removed and	Yes  Do we want to define temporarily.

Commented [RA6]: I think "temporarily" is defined by stating, "must be reattached before operator leaves".

Item 20-34 (merged with 20-35, 20-40)

July 2021 - NBIC Part 1

	reattached, must be attached when open.	
e) A removable handle is permitted in certain conditions (creates a personnel hazard or obstruction). In these cases, the handle must meet all of the following:  1) Handle remains installed when valve is open 2) Handle can only be reattached so the handle is perpendicular to the flow in a closed position 3) Valve position is indicated, with or without handle 4) Upon removal, the handle must be turned and reattached 180 deg to remove hazard or tethered no more than 3 ft away and usable trouble free without untethering 5) A handle tethered in 4) above shall only be permitted when the line is tagged/locked out to prevent operation	Do we want to go into this level of detail?	MAYBE
f) A manually operated valve shall be provided upstream from all other main gas controls to isolate the fuel train  1) Valve shall be within 6 ft of the boiler and accessible from the floor 2) When a valve is not required per h), then the valve require by f) shall be located immediately external to the boiler/burner unit		Yes
g) When the pilot gas is obtained independently or upstream of the manual shutoff valve, a separate manual valve (per a-e) shall be located in the gas supply line to the pilot. When the pilot is downstream of f) one or more manual valves or other means to permit turndown tests and/or pressurization of the pilot without pressurizing the main fuel train.	But only on the pilot being independent or upstream of the manual shut off valve.	Yes
h) A manually operated shutoff valve in 1-e shall be provided after the downstream SSV to the main burner or group of burners if required by the boiler/burner mfg for testing or maintenance.	How does the inspector know what the Mfg requirements are.	No

**Commented [RA7]:** Yes...I think we should discuss the instances of when a removable handle is permitted if it we are going to allow it in the NBIC.



Item 20-34 (merged with 20-35, 20-40)

July 2021 - NBIC Part 1

I would suggest a paragraph in the following manner.

A manual valve is required upstream of all controls and within 6 ft of the boiler to isolate the fuel train. If a pilot line is independent from the main gas train, it shall also have a manual valve. These manual valves shall be accessible from the floor and designed to be opened/closed without additional tools. They shall be valve ball or plug type with a non-removable handle that is perpendicular to the gas flow when closed and parallel when open. The handle can be temporarily removed if.... At all times, the position of the valve shall be indicated.

**Commented [RA8]:** I understand what the intent is by saying "within 6 ft. of the boiler"; however, is this ambiguous in that someone could think it has to be within 6 ft. of the boiler in the gas train?

**CF-160 – Gas pressure Regulators**

CF-160 Gas Pressure Regulators		
a) Individual Gas pressure regulators or regulators that are part of a combination valve shall be used for both the pilot and main gas per ANSI Z21.78/CSA 6.2. Regulated pressure shall be within +/- 10% set pressure at all firing rates. Pressure test port required	Do we need to specify equipment downstream of the gas shutoff valve or rely on the 1.6.5 and the reliance on an industry standard?	Committee Question
b) Regulators with integral vent limiters – meet ANSI Z21.18/CSA 6.3.		No
c) Second stage regulators for LPG gas (alone or in combo) must comply with UL 144 and installed per NFPA 58		No

**Commented [RA9]:** Just as you specified with CF-160 – CF-180, I think gas pressure regulators, control valves, and SSV's are specific to fuel train systems and should NOT be part of the NBIC.

We don't get into specific's about burners; therefore, why would we get into specifics about fuel train components?

I think we stop after the manually operated gas shutoff valve. If we include gas pressure regulators, etc. then we have to include all gas train components, in my opinion and I don't believe that's within the scope of the NBIC.

CF-161 – Overpressure Protection		
a) If the MAWP of any component is less than the entering gas pressure so a regulator failure would produce pressure above the MAWP, the downstream piping system shall have overpressure protection.	See CF 160	
b) If OP protection is require, it shall be located upstream of all controls for both the burner and the Pilot. OP devices shall be vented to safe point of discharge, if required.		

Item 20-34 (merged with 20-35, 20-40)

July 2021 - NBIC Part 1

c) CG-210 is referenced. (NFPA 54 gas, NFPA 31 oil and NFPA 58 LP gas)		
d) OP, if required, may be provided by any device listed in the latest NFPA 54/ANSI Z223.1		

CF-162 – Gas Pressure Supervision		
a) Gas pressure supervision shall be provided based on heat input and firing system type (power, mech draft, pulse – or – natural draft.) to accomplish a safety shutdown and lockout in the event of either high or low gas pressure.	See CF 160	
b) Location 1) High pressure downstream of main regulator – Switch locks out before the manifold gas pressure exceeds a) The boiler/burner manufacturer's specified setting b) 150% of the boiler/burner main manifold gas pressure if not specified by manufacturer		
2) High pressure upstream of main regulator – the regulator must be a zero governor pressure regulator. The high pressure switch locks out when the supply pressure exceeds a) The setting of the OP protection device in CF 161 if equipped. b) The boiler/burner manufacturers specified setting c) 150% of the boiler/burner main manifold gas pressure if not specified by manufacturer		

Item 20-34 (merged with 20-35, 20-40)

July 2021 - NBIC Part 1

<p>A high gas pressure switch is not required when a boiler unit incorporates a listed shutoff valve with a zero governor pressure regulator that causes a safety shutdown if the zero governor pressure regulator fails due to a ruptured diaphragm</p>		
<p>c) Low gas pressure shall function to accomplish a safety shutdown before the main manifold gas pressure is less than</p> <ol style="list-style-type: none"> <li>1 The boiler/burner manufacturer's specified setting</li> <li>2 50% of the boiler/burner's main manifold gas pressure if the setting is not specified.</li> </ol> <p>The low gas pressure switch shall be located upstream of the SSVs. When the low gas-pressure switch is located upstream of the main gas-pressure regulator, the burner or boiler unit shall be labeled and listed by a nationally recognized testing agency for this arrangement.</p>	<p>See CF-160</p> <p>No – Even if we do agree that switches should be included.</p>	
<p>d) Pressure test port(s) are required</p>		
<p>e) Gas-pressure switches shall be labeled and listed</p>	<p>As part of 1.6.5?</p>	
<p>f) Switches shall be capable of withstanding a pressure not less than 10% above the relieving pressure of the nearest upstream OP device. When no relief is provided, the switches shall be capable a pressure not less than the maximum inlet pressure of the nearest gas-pressure</p>	<p>No.</p> <p>Even in we do agree that switches should be included.</p>	

Item 20-34 (merged with 20-35, 20-40)

July 2021 - NBIC Part 1

regulator. When the high gas-pressure switch is located downstream of the SSV, the switch shall be capable of withstanding a pressure no less than 50% above it's upper set point limit.		
g) Gas-pressure switches of the automatic or manual reset type shall be electrically connected in accordance with CE-110(j)	No	

## Part 1

## CF-170 – Control Valves

CF – 170 – Control Valves		
a) An automatic input, complete closure, control valve may be combined with a SSV.	See CF 160	
b) A bypass valve may be installed only around a control valve, not any valve that is a shutoff		

## CF-180 Safety Shutoff Valves (SSV)

CF-180 Safety Shutoff Valves (SSV)		
a) Each main and pilot shall have a SSV that is compliant with one of the ANSI/CSA or UL 429	See CF 160	
b) Single burners main burner supply line shall be equipped as follows <ul style="list-style-type: none"> <li>1) <math>\leq</math> 500K, Two safety shutoff in series (can be single body) or one safety shutoff with a proof of closer interlock. If the two shutoff valves are in on body, they shall be in series with independently operated shafts</li> <li>2) <math>\geq</math> 500 K up to 12.5 million, Two SSVs in series that may be in a single valve body. At least one shall</li> </ul>		

Item 20-34 (merged with 20-35, 20-40)

July 2021 - NBIC Part 1

<p>incorporate a proof of closure interlock. If the two shutoff valves are in on boy, they shall be in series with independently operated shafts</p> <p>3) If there is a branch line to a second burner, either a or b following apply</p> <ul style="list-style-type: none"> <li>a. &lt;500K b) 1) applies</li> <li>b. &gt;500K up to 12.5 million – <ul style="list-style-type: none"> <li>1) Safety shutoff in b)1) applies to each branch or</li> <li>2) At least one SSV on the main and one on the branch shall incorporate a proof of closure interlock</li> </ul> </li> </ul>		
<p>c) For multiple burner units the main burner shall be equipped as follows</p> <ul style="list-style-type: none"> <li>1) &lt;= 500 k safety shut off in b)1) applies to each individual line</li> <li>2) &gt;500K up to 12.5 million, either of the following applies <ul style="list-style-type: none"> <li>a. SSV requirements in b)2) applies to each line</li> <li>b. SSV requirements in b)1) apply to each line and the main burner supply line has at least one SSV with proof of closure interlock.</li> </ul> </li> </ul>		
<p>d) The valve seal overtravel (proof of closure) interlock shall prevent boiler ignition if the switch does not prove the valve closed during the startup</p>		
<p>e) Pilot supply line shall be equipped with at least one SSV</p>		
<p>f) SSVs labeled, listed by a national...</p>		
<p>g) SSVs shall have a shutoff time not to exceed that specified in Tables CF1-4</p>		
<p>h) SSV's shall be capable of withstanding a pressure not less than 10% above closest upstream OP device. If no OP device, the valves can withstand a pressure not less than maximum inlet to regulator</p>		
<p>i) Provisions to independently test each SSV for seal leakage. Any special</p>		

Item 20-34 (merged with 20-35, 20-40)

July 2021 - NBIC Part 1

equipment made available to boiler/burner mfr.		
--	--	--

CF-190 – Vent, Bleed, Gas-pressure relief, vent valve, and feedback LINES for fuel train components.

<p>a) <i>Vent Lines</i></p> <p>1) Regulators, combination controls, pressure interlock switches and all components requiring atmosphere air pressure shall have the atmospheric side of the diaphragm connected to a vent line that shall be pipe outside to a safe point of discharge as determined by the AHJ unless allowed in c) or h) below.</p> <p>2) Where there is more than one fuel train component requiring a vent, each component shall have a separate vent piped outside to the safe place of discharge (per AHJ) unless otherwise permitted by f) or h).</p>	<p>Yes. Maybe combine all into one paragraph.</p> <p>Vent or bleed lines coming from gas equipment such as regulators, controls, etc. shall be vented outside to a safe point of discharge. Sizing of vents, manifolding etc. should be per the applicable accepted standard.</p> <p>Vent to safe point of discharge per the standard or the AHJ.</p>	
<p>b) <i>Bleed lines</i></p> <p>1) Regulators, combination controls, pressure interlock switches and all components requiring atmosphere air pressure and periodically release gas shall have the atmospheric side of the diaphragm connected to a bleed line that shall be piped outside to a safe point of discharge as determined by the AHJ unless allowed in c) or h) below.</p> <p>2) Where there is more than one fuel train components requiring a bleed line at a location, each component shall have a separate bleed line piped outside to the safe place of discharge (per AHJ) unless otherwise permitted by f) or h).</p>		
<p>c) <i>Components with Vent Limiters.</i> A listed and labeled gas-pressure regulator, etc. or other fuel train component incorporating a vent limiter shall be permitted to vent directly into ambient space</p>		

**Commented [RA10]:** I agree that CF-190 should be included in the NBIC and I also agree that it should be condensed similarly to what is described here.

Item 20-34 (merged with 20-35, 20-40)

July 2021 - NBIC Part 1

<p>d) Gas-pressure relief lines</p> <ol style="list-style-type: none"> <li>1) If an OP device incorporates a gas-pressure relief device, the outlet shall be connected to a relief line piped outside to the safe place of discharge (per AHJ)</li> <li>2) The relief line shall be sized in accordance with the component manufacturer's instructions and shall be at least the same size as the outlet connection of the relief valve</li> <li>3) Where there is more than one gas-pressure relief valve, each relief valve shall have a separate line piped outside to the safe place of discharge (per AHJ) unless otherwise permitted by f).</li> </ol>		
<p>e) <i>Lines from vent valves</i></p> <ol style="list-style-type: none"> <li>1) A vent valve, if installed shall be piped outdoors to a safe point of discharge as determined by the AHJ</li> <li>2) Vent line shall be <math>\geq</math> to the outlet connection</li> <li>3) Where there is more than one vent valve at a location, each vent valve shall be piped outside to the safe place of discharge (per AHJ) unless otherwise permitted by f).</li> </ol>		
<p>f) <i>Manifolding of Lines</i></p> <p>If approved by the AHJ, same type lines (vent, bleed) shall be permitted and vent and bleed manifolding is permitted. To minimize backpressure, the manifolded line shall have a cross-sectional area of not less than the area of the largest branch line piped + 50% of the additional cross-sectional areas. The following manifolding is not permitted</p> <ol style="list-style-type: none"> <li>1) Gas-pressure relief with vent line, bleed lines or vent valve lines</li> <li>2) Vent valve lines with vent lines or bleed lines</li> <li>3) No vent lines of any type from one boiler to another</li> </ol>		
<p>g) <i>Connecting lines to Flue Passages</i></p> <p>No vent lines of any type shall connect to a boiler's flue passages</p>		

Item 20-34 (merged with 20-35, 20-40)

July 2021 - NBIC Part 1

<p><i>h) Points of discharge: Outdoor requirements, special exceptions, and prohibited practices</i></p> <ol style="list-style-type: none"> <li>1) Unless terminated per 2) or 4) all lines shall be piped outside to the safe place of discharge (per AHJ). The point of discharge shall be protected from foreign material.</li> <li>2) A combination gas control integrating an internal gas bleed line shall be permitted to discharge its bleed line back into the valve body – if designed to not leak into burner.</li> <li>3) If prone to floods, the discharge shall be protected (anti-flood or raise height)</li> <li>4) A bleed or vent line can be discharged into a pilot if it is not a manifolded line and the discharge uses a burner tip.</li> <li>5) Bleed or vent line shall not discharge into a positive pressure combustion chamber</li> </ol>		
<p><i>i) Clearance for Points of Discharge</i></p> <p>The point of discharge from the referenced vents piped outside shall have clearance as determined by the AHJ and the point of discharge shall extend above boiler and structures to prevent gaseous discharge from being drawn into combustion air intakes, ventilating systems, mechanical air intakes, windows of the boiler room or of an adjacent building.</p>		
<p><i>j) Burner tips</i></p> <ol style="list-style-type: none"> <li>1) If used per h)4) – metal with a melting point of +1,450 F and its length shall extend from location in 3) to the outer wall of the combustion chamber.</li> <li>2) Installer to document compliance and provide documentation accompanying the boiler</li> <li>3) Burner tip location shall be located so the gas is readily ignited and the tips securely held in relation to the pilot.</li> </ol>		



Item 20-34 (merged with 20-35, 20-40)

July 2021 - NBIC Part 1

<p>k) <i>Feedback Lines for Fuel Train components</i></p> <p>Feedback lines – Piped per manufacturer's instructions</p>		
<p>l) <i>Bleed, Vent, and Relief lines</i></p> <p>All materials for these lines must be strong and durable enough and suitable for the environmental stresses. Materials shall be listed for intended purpose by a nationally recognized standard as accepted by the AHJ. In the absence of a standard NFPA 54 shall be used.</p>		

Reminder

**FROM NBIC PART 1****1.4.1 RESPONSIBILITY**

- a) The owner is responsible for satisfying jurisdictional requirements for certification and documentation. When required by jurisdictional rules applicable to the location of installation, the boilers, pressure vessels, piping, and other pressure-retaining items shall not be operated until the required documentation has been provided by the installer to the owner and the Jurisdiction.
- b) The National Board Commissioned Inspector providing inservice inspection for the facility in which the pressure-retaining item is installed has the following responsibilities:
- 1) Verify the *Boiler Installation Report* (I-1 Report) has been completed and signed by the installer, when required by the Jurisdiction;
  - 2) Verify pressure-retaining items comply with the laws and regulations of the Jurisdiction governing the specific type of boiler or pressure vessel;
  - 3) Verify any repairs or alterations to pressure-retaining items, which are conducted prior to, or during, the initial installation, are in accordance with the NBIC;
  - 4) Request or assign jurisdictional identification number, when required by the Jurisdiction; and
  - 5) Complete and submit the first inservice inspection/certificate report to the Jurisdiction when required by the Jurisdiction.
- c) Unless otherwise specifically required by the Jurisdiction, the duties of the inservice inspector do not include the installation's compliance with manufacturer's recommendations or applicability of, or compliance with, other standards and requirements (e.g., environmental, construction, electrical, undefined industry standards, etc.) for which other regulatory agencies have authority and responsibility to oversee.

## Oil burners Item 20-35

### Oil Fuel Requirements

A strainer or filter shall be installed upstream of the safety shutoff valves. The filter or strainer shall meet the manufacturer's recommendations and installed in accordance with jurisdictional and environmental requirements and/or industry standards, as applicable.

#### **Rational**

Most of the CSD-1 requirements are not addressed as we assume this is a listed burner, and those requirements are part of the listing.

CG-430 requires a filter or strainer upstream of the safety shutoff valves, and these are not part of the listed burner, but required at installation.

Gene Tompkins

7-13-21

Item Number: 20-41

ASME CSD-1 2018 Edition

CW-510 Requirements for Steam and Hot-Water Heating Boilers

The safety and safety relief valves of all steam and hot-water heating boilers shall conform to the ASME Boiler and Pressure Vessel Code, Section I or Section IV, as applicable.

NBIC Part I 2019 Edition

2.9.1 (b) Pressure relief valve shall be manufactured in accordance with a national or international standard and be certified for capacity or flow resistance by the National Board.

**Commented [TB1]:** Correct paragraph reference is b)

**Commented [TB2]:** Flow resistance only applies to Section VIII non-reclosing pressure relief devices. It would not be appropriate to reference flow resistance here.

3.9.2 (a) Pressure Relief Valve requirements for steam heating boilers

**Commented [TB3]:** Correct paragraph reference is 3.9.2

(a) Pressure relief valve shall be manufactured in accordance with a national or international standard and be certified for capacity or flow resistance by the National Board.

**Commented [TB4]:** Flow resistance only applies to Section VIII non-reclosing pressure relief devices. It would not be appropriate to reference flow resistance here.

NBIC Part 4 2019 Edition

2.2.1b) Pressure relief valves shall be manufactured in accordance with a national or international standard and be certified for capacity by the National Board.

2.4.2 a) Pressure relief valves shall be manufactured in accordance with a national or international standard and be certified for capacity by the National Board.

Item Number: 20-43

ASME CSD-1 2018 Edition

CW-510 Requirements for Hot-Water Supply Boilers

The safety and safety relief valves of all hot-water supply boilers shall conform to the ASME Boiler and Pressure Vessel Code, Section I or Section IV, as applicable.

Part 1, 2019 Ed.

3.9.3 (a) Pressure relief valve shall be manufactured in accordance with a national or international standard and be certified for capacity or flow resistance by the National Board.

**Commented [TB1]:** Flow resistance only applies to Section VIII non-reclosing pressure relief devices. It would not be appropriate to reference flow resistance here.

Part 4, 2019 Ed.

2.4.3 a) Pressure relief valves shall be manufactured in accordance with a national or international standard and be certified for capacity by the National Board.

It is intended that the number be **3.8.1.7** and that the item currently **3.8.1.7** becomes **3.8.1.8**

### **3.8.1.7 Vacuum Boilers**

Vacuum Boilers shall be provided with instruments, fittings and controls in accordance with Section 3.8 but are exempt from the following requirements if pressure and temperature controls are installed as described in 3.8.1.7 below:

<u>3.8.1.2</u>	<u>Water-Gage Glasses</u>
<u>3.8.1.3</u>	<u>Water Column and Water Level Control Piping</u>
<u>3.8.1.4</u>	<u>Pressure Control</u>
<u>3.8.1.5</u>	<u>Auto Low Water Cut-Off and /or Water feeding device</u>
<u>3.7.7</u>	<u>Blow Off and Drain Valves</u>

The exemptions are allowed only when the following controls are installed:

- a) Pressure Control – Each boiler shall have a pressure control that interrupts the burner operation in response to boiler pressure. This pressure control shall be set from 2.5 psig (17 kpa) to 14.7 psig (101 kpa).
- b) Temperature Control- Each boiler shall have two temperature controls responsive to boiler temperature that interrupt burner operation. One shall operate at a temperature below 210°F (99°C). The other shall at a temperature not exceeding 210°F (99°C) and shall cause a safety shutdown and lockout.
- c) Safety Relief Valves - Each boiler shall have a properly sized safety valve and shall conform to the following.
  1. Have no test lever
  2. Be set to a maximum pressure of 7.1 psig (49 kpa).
  3. ASME Boiler and Pressure Vessel Code Section IV

References:

CSD-1 CW-700

### **CW-710 Requirements for Vacuum Boilers**

Vacuum boilers complying with ASME Boiler and Pressure Vessel Code, Section IV, Mandatory Appendix 5 shall be permitted to have the safety limit controls meeting the requirements identified in (a), (b), (c), and

(d) in lieu of all other requirements in [Part CW](#).

(a) Each boiler pressure and temperature control shall conform to UL 353, Standard for Limit Controls, and shall be accepted by a nationally recognized testing agency.

(b) Each boiler shall have a pressure control that interrupts the burner operation in response to boiler pressure. This pressure control shall be set from 2.5 psig (17 kPa) vacuum to 14.7 psig (100 kPa) vacuum.

(c) Each boiler shall have two temperature controls responsive to boiler temperature that interrupt burner operation. One shall operate at a temperature below 210°F (99°C). The other shall operate at a temperature not exceeding 210°F (99°C) and shall cause a safety shutdown and lockout.

(d) Each boiler shall have a properly sized safety valve. The safety valve shall

- (1) have no test lever.
- (2) be set at a maximum pressure of 7.1 psig (49 kPa)
- (3) conform to the ASME Boiler and Pressure Vessel Code, Section IV

#### ASME Sec IV

#### Mandatory Appendix 5 Vacuum Boilers

#### 5-600 Instruments, Fittings and Controls

Vacuum boilers shall be provided with instruments, fittings, and controls in accordance with Articles 6 and 7 of part HG, but they are exempt from the following requirements if pressure and temperature controls are provided as described in (a), (b), and (c) below:

Paragraph	Title
HG-603	Gage Glass
HG-604	Water Column
HG-605	Pressure Control (second control only)
HG-606	Low Water Cut-Off
HG-703.2	Return Pipe Connection
HG-705	Feedwater Connection
HG-715	Blowoff and Drain Valves

These exemptions are applicable only when the following devices are installed:

- (a) Pressure Control. A pressure control that interrupts the burner operation in response to boiler pressure, and is set at 2.5 psig vacuum (12.2 psia) (17kPa)
- (b) Temperature Control. Two temperature controls responsive to boiler temperature that can interrupt burner operation, one shall operate at a temperature below 210°F (99°C) and the other shall prevent the temperature from exceeding 210°F (99°C) with no automatic recycle. The use of a fusible plug to perform the second of these two functions is permissible.

- (c) Safety Valve. A safety valve without a test lever, set at 7.1 psig (22psia) (49 kPa gage) maximum pressure and sized in accordance with HG-400

NBIC Item # 20-86

NBIC Location: Part 1, 2.10.1 a) Testing and Acceptance: Boil Out

Recommended Verbiage – DP 1/14/21

It is recommended that a newly installed boiler(s) be boiled out. Its internal surfaces could be fouled with oil, grease, and/or other protective coatings from the manufacturing of the boiler. Boiling out will also remove any remaining mill scale, rust, welding flux, or other foreign matter normally associated with manufacturing or shipment. All contamination needs to be removed since it lowers the heat transfer rate and could cause localized overheating.

Existing boilers that have had any tube replacement, re-rolling or other extensive repairs to the pressure parts should also be boiled out. The lubricant used for rolling tubes, plus the protective coating on the new tubes, must be removed by boiling out before the repaired boiler can be put back on the line.

There are several methods used to perform the boil out operation. The boil out chemicals that are added to the water create a highly caustic solution, which upon heating dissolves the oils and greases and takes them into solution. After the period of boil out and blowing down the boiler, the concentration is diluted enough that practically all the oils and greases and other matter have been eliminated.

For new system installed the condensate return from the system should be dumped as this piping could also contain contaminants that could result in being put back into the boiler(s). The time for this should be determined on the size of the system.

Refer to the manufacturer and/or a chemical treatment company or specialist for the recommended chemicals and procedure to follow.





**PROPOSED REVISION OR ADDITION**

<b>Item No.</b>
20-86
<b>Subject/Title</b>
Testing and Acceptance: Boiling-out Procedure
<b>NBIC Location</b>
Part: Installation; Section: 2.10; Paragraph: 2.10.1 (a)
<b>Project Manager and Task Group</b>
Edward Wiggins, Subcommittee Installation
<b>Source (Name/Email)</b>
Edward Wiggins / Edward.Wiggins@labor.alabama.gov
<b>Statement of Need</b>
This was brought to my attention by Ernest Brantley. Mr. Brantley indicated during an acceptance inspection, he found boiler with excessive oil on the tubes and tube sheet after boiler was delivered and installed. He could not find any reference to boil- out to remove this extraneous material.
<b>Background Information</b>
ASME Sec VII 101.2 Preparing For Operation 101.2.2: Chemical Cleaning. New power boilers are generally cleaned internally by a boiling-out procedure using a chemical solution.
<b>Existing Text</b>
<b>Proposed Text</b>
New Power Boilers should be cleaned internally by a boiling out procedure to remove any grease, oil,solvents or rust inhibitors applied to the internal parts of the boiler prior to being placed in service.

	<b>VOTE:</b>						
<b>COMMITTEE</b>	<b>Approved</b>	<b>Disapproved</b>	<b>Abstained</b>	<b>Not Voting</b>	<b>Passed</b>	<b>Failed</b>	<b>Date</b>

## **CODE REVISIONS OR ADDITIONS**

Request for code revisions or additions shall provide the following:

**a) Proposed Revisions or Additions**

For revisions, identify the rules of the code that require revision and submit a copy of the appropriate rules as they appear in the code, marked up with the proposed revision. For additions, provide the recommended wording referenced to the existing code rules.

**b) Statement of Need**

Provide a brief explanation of the need for the revision or addition.

**c) Background Information**

Provide background information to support the revision or addition, including any data or changes in technology that form the basis for the request that will allow the Committee to adequately evaluate the proposed revision or addition. Sketches, tables, figures, and graphs should be submitted as appropriate. When applicable, identify any pertinent paragraph in the code that would be affected by the revision or addition and identify paragraphs in the code that reference the paragraphs that are to be revised or added.

## ASME BPVC.VII-2021

ANSI/ASSP Z359, Fall Protection Code

Publisher: American Society of Safety Professionals (ASSP), 520 N. Northwest Hwy, Park Ridge, IL 60068 (<https://www.assp.org>)

**101.1.6.2 Regulations.** Applicable federal, state and/or local regulations addressing this equipment and its operation [e.g., U.S. federal Occupational Safety and Health Administration (OSHA) regulations].

**101.1.6.3 Additional Sources of Information.**

- (a) Boiler manufacturer's manuals provide information on
  - (1) equipment operation and maintenance
  - (2) feedwater and boiler-water quality requirements
- (b) Fuel equipment manufacturer's manuals provide information on
  - (1) equipment operation and maintenance
  - (2) fuel handling, preparation, and burning
  - (3) combustion safeguard systems
- (c) Boiler insurance companies
  - (1) can answer Boiler Code compliance questions
  - (2) offer inspection service
  - (3) publish operation and inspection guides
  - (4) recommend repairs and alterations
  - (5) compile accident or failure statistics

## 101.2 PREPARING FOR OPERATION

**101.2.1 Inspection.** A new or relocated power boiler should not be put into operation until it has been inspected by an Authorized Inspector for the jurisdiction or Authorized Insurance Agency and the required certificates have been issued.

**101.2.2 Chemical Cleaning.** New power boilers are generally cleaned internally by a boiling-out procedure using a chemical solution. The cleaning of existing boilers may be done mechanically, chemically, or both, depending on the arrangement and accessibility of the heating surfaces and the type of deposits. Acid cleaning, if used, should be done under the supervision of experienced personnel thoroughly familiar with the hazards of such operations. Chemical cleaning contractors can provide specialized equipment and trained personnel.

**101.2.3 Safety Checklist for Boiler Examination.**

- (a) Before entering any boiler, lock out and tag all equipment items with movable parts connected to the boiler and fuel system and place a sign at the operating controls indicating that personnel are in the boiler. An "Entry Watch" and personal protective equipment may also be required.
- (b) Before entering any boiler, ensure that it is properly isolated at all potential sources of fuel, flue gas, steam, and water, and that it is properly vented; obtain an air sample to check for breathing quality. Use low-voltage lights, explosion-proof electric lights, or explosion-proof flashlights inside the boiler. See 105.3.1 for more details and requirements for using higher-voltage service.
- (c) Notify the person in charge at the site when beginning and upon completion of the examination.
- (d) Examine with another person so if assistance is required help will be close at hand.
- (e) Always be aware of the nearest escape routes.
- (f) Before closing drum manholes and furnace doors, ensure that all personnel are out of the boiler.

**101.2.4 Water-Side Checklist.**

- (a) Ensure that the water side of the boiler, including drums, tubes, and headers, is free of extraneous material such as dirt, tools, rags, wood, or trash.
- (b) Ensure that all internal fittings are in serviceable condition and securely installed in the correct position.
- (c) Look for cracking and for evidence of corrosion on pressure parts.
- (d) Look for erosion at mating surfaces of manways, handhole caps, and flanges.
- (e) Note the location and type of deposits in boilers that have previously been in operation, and collect samples for analysis.

Item 21-01

Proposal: Revise paragraph 3.7.5.1. d) 4) to clarify that valves without packing glands may be used as stop valves.

Explanation: There are valve designs using means other than adjustable packing to prevent leakage through the stem which are suitable for use as isolation (stop) valves.

Note: ASME BPV IV has approved a change to the 2023 Edition with the same wording under their item 21-391

### 3.7.5 STOP VALVES

#### 3.7.5.1 STEAM HEATING, HOT-WATER HEATING, AND HOT-WATER SUPPLY BOILERS

##### a) For Single Steam Heating Boilers

When a stop valve is used in the supply pipe connection of a single steam boiler, there shall be one installed in the return pipe connection.

##### b) For Single Hot-Water Heating & Hot-Water Supply Boilers

- 1) Stop valves shall be located at an accessible point in the supply and return pipe connections as near the boiler as is convenient and practicable, of a single hot water boiler installation to permit draining the boiler without emptying the system.
- 2) When the boiler is located above the system and can be drained without draining the system stop valves required in NBIC Part 1, 3.7.5.1 b) 1) may be eliminated.

##### c) For Multiple Boiler Installations

A stop valve shall be used in each supply- and-return pipe connection of two or more boilers connected to a common system. See NBIC Part 1, Figures 3.7.5.1-a, 3.7.5.1-b, and 3.7.5.1-c.

##### d) Types of Stop Valve(s)

- 1) All valves or cocks shall conform with the applicable portions of an acceptable code of construction and may be ferrous or nonferrous.
- 2) The minimum pressure rating of all valves or cocks shall be at least equal to the pressure stamped upon the boiler, and the temperature rating of such valves or cocks, including all internal components, shall be not less than 250°F (121°C).
- 3) Valves or cocks shall be flanged, threaded or have ends suitable for welding or brazing.
- 4) All valves or cocks with stems or spindles shall have adjustable pressure-type packing glands or alternate design to prevent leakage around the stem, and, in addition, all plug-type cocks shall be equipped with a guard or gland. The plug or other operating mechanism shall be distinctly marked in line with the passage to indicate whether it is opened or closed.
- 5) All valves or cocks shall have tight closure when under boiler hydrostatic test pressure.